

Features

- Low-loss RF filter
- High Rejection
- Single Ended Operation at 50Ω without matching
- Ceramic Package for **Surface Mounted Technology (SMT)**
- Lead-free Production and **RoHS Compliance**

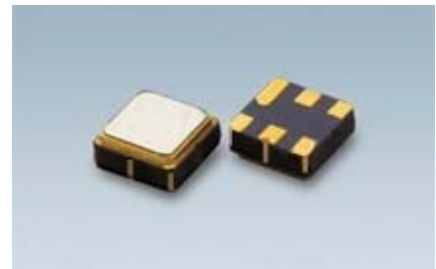

Package Dimensions

Ceramic Package: **DCC6C**



Pin Configuration

2	Input
5	Output
1, 3, 4, 6	Case Ground
1, 3, 4, 6	To Be Grounded

Marking



Top View, Laser Marking

- "ND": Manufacturer's mark
- "F": SAW filter
- "9235": Part number
- ".": Terminal 1
- "*": Lot number (The code shown below varies in a 4-year cycle)

Code	1	2	3	4	5	6	7	8	9	10	11	12
2009	A	B	C	D	E	F	G	H	J	K	L	M
2010	N	P	Q	R	S	T	U	V	W	X	Y	Z
2011	a	b	c	d	e	f	g	h	i	j	k	m
2012	n	p	q	r	s	t	u	v	w	x	y	z

Maximum Ratings

Rating		Value	Unit
Operating Temperature Range	T_A	-40 ~ +85	°C
Storage Temperature Range	T_{stg}	-40 ~ +85	°C
DC Voltage (between any Terminals)	V_{DC}	12	V
RF Power (in BW)	P	10.	dBm

Electrical Characteristics

Item		Minimum	Typical	Maximum	Unit
Center Frequency	f_c	-	1048	-	MHz
Maximum Insertion Loss in 1037.5 MHz–1058MHz	IL	-	1.8	2.6	dB
Amplitude Variation in 1037.5 MHz–1058MHz			0.5	1.0	dB
Absolute Attenuation	α				
0.30 ... 400.00MHz		45	50	-	dB
400.00 ... 970.00MHz		40	50	-	dB
970.00 ... 976.00MHz		40	45	-	dB
1090.00 ... 1213.00MHz		40	45	--	dB
1710.00 ... 2000.00MHz		40	45	--	dB
2000.00 ... 3000.00MHz		28	33	--	dB
Input VSWR in 1037.5 MHz–1058MHz		-	1.5: 1	2.0:1	
Output VSWR in 1037.5 MHz–1058MHz		-	1.5: 1	2.0:1	
Group delay ripple 1037.5 MHz–1058MHz			15	40	ns
Source / Load Impedance (single ended)			50		Ω

RoHS Compliant

Electrostatic Sensitive Device

Typical Frequency Response

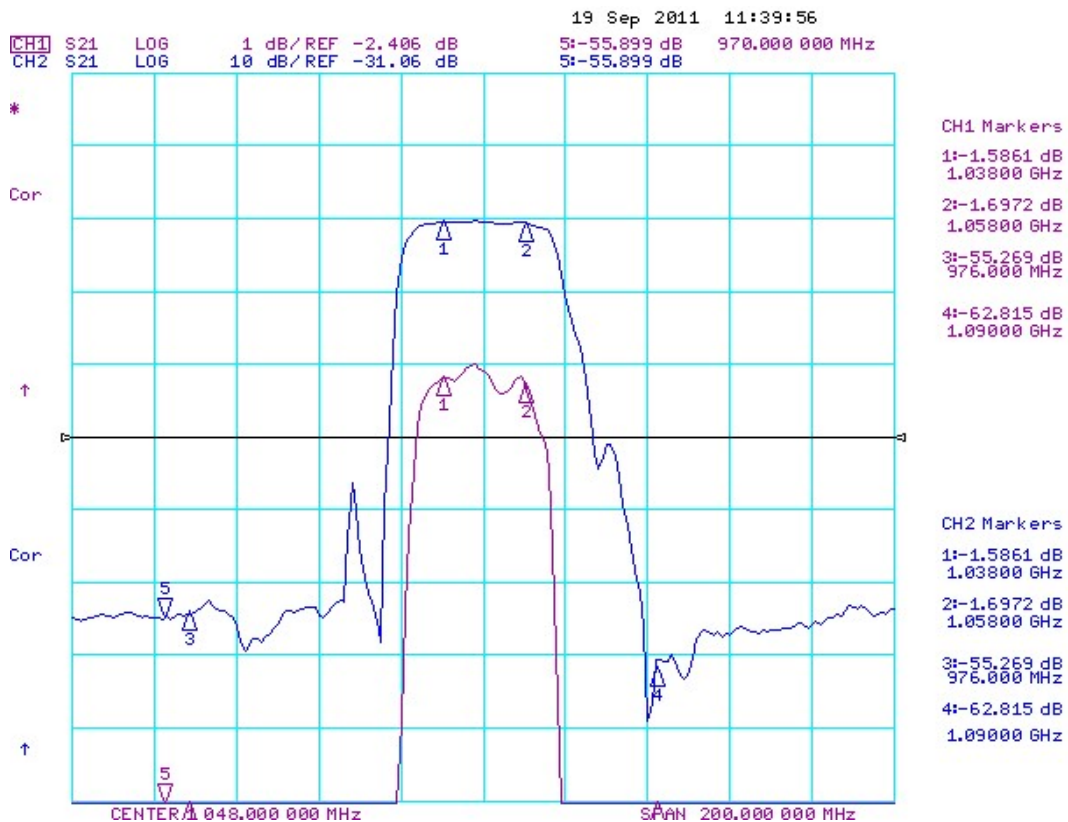

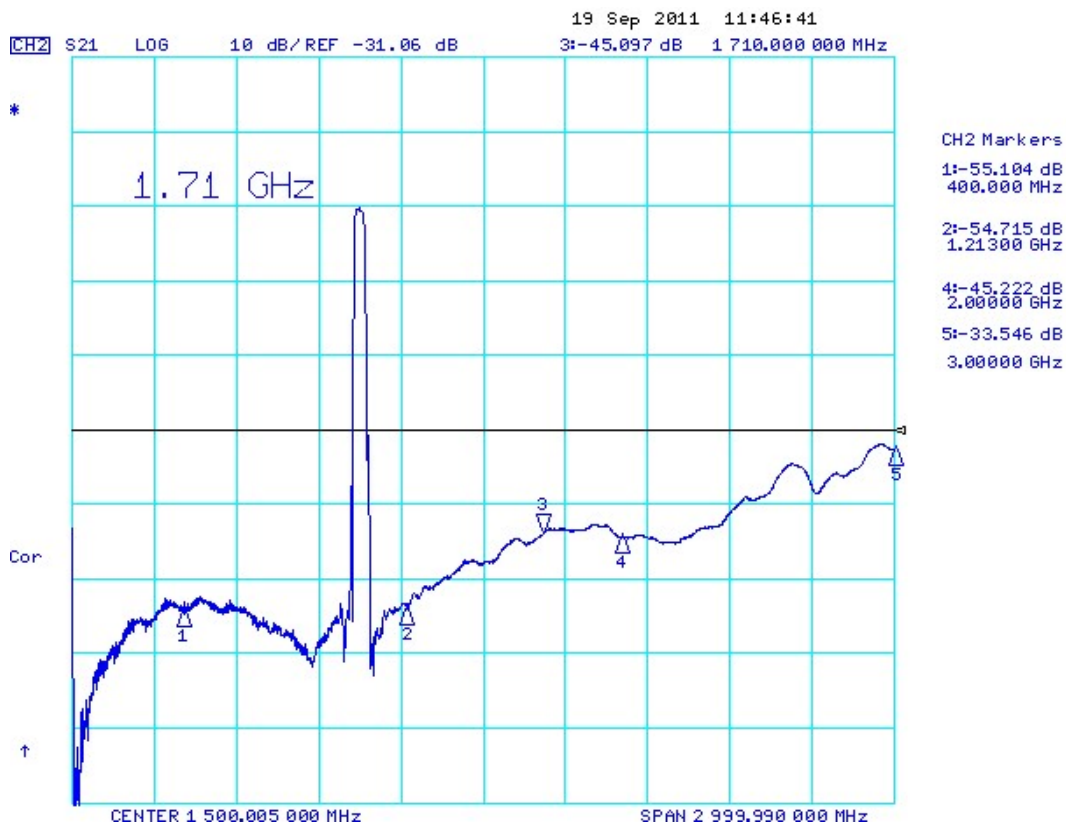
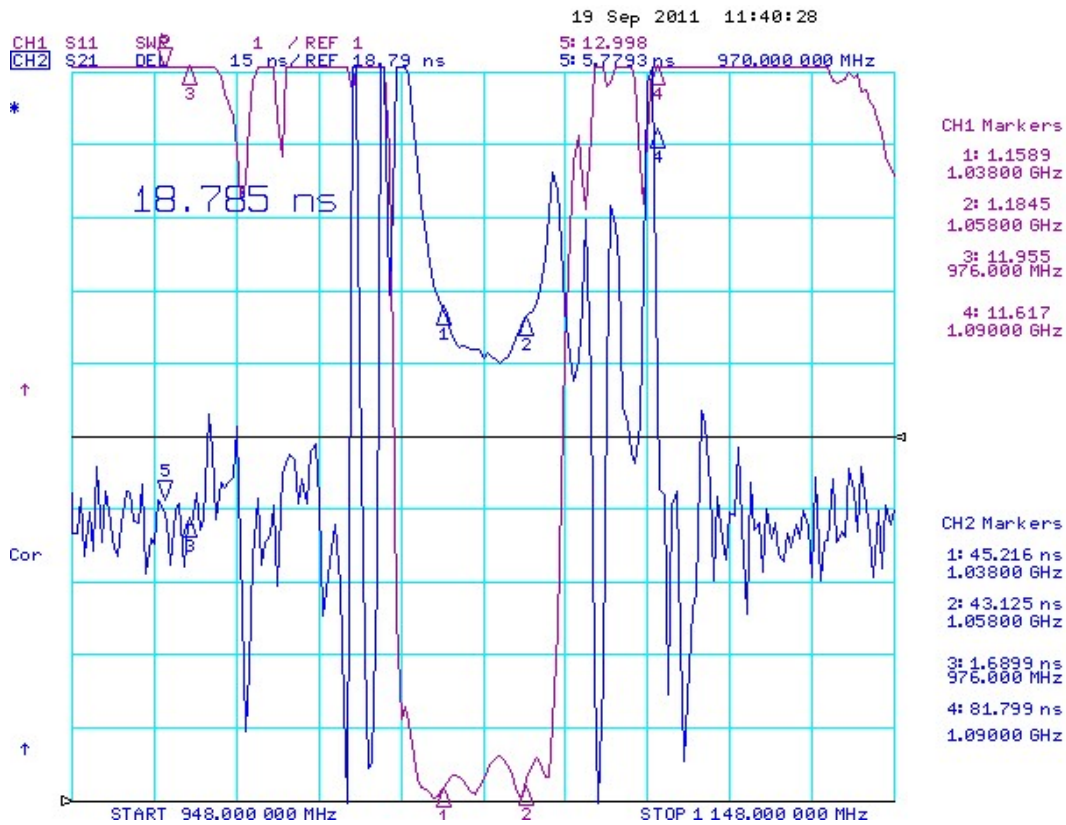

Stability Characteristics

	Test item	Condition of test
1	Mechanical shock	(a) Drops: 3 times on concrete floor (b) Height: 1.0 m
2	Vibration resistance	(a) Frequency of vibration: 10~55Hz (c) Directions: X,Y and Z (b) Amplitude: 1.5 mm (d) Duration: 2 hours
3	Moisture resistance	(a) Condition: 40°C, 90~95% R.H. (c) Wait 4 hours before measurement (b) Duration: 96 hours
4	Climatic sequence	(a) +70°C for 16 hours (c) -25°C for 2 hours (e) Wait 4 hours before measurement (b) +55°C for 24 hours, 90~95% R.H. (d) +40°C for 24 hours, 90~95% R.H.
5	High temperature exposure	(a) Temperature: 70°C (c) Wait 4 hours before measurement (b) Duration: 250 hours
6	Thermal impact	(a) +70°C for 30 minutes ⇒ -25°C for 30 minutes repeated 3 times (b) Wait 4 hours before measurement

Requirements: The SAW filter shall remain within the electrical specifications after tests.

Remarks

- SAW devices should not be used in any type of fluid such as water, oil, organic solvent, etc.
- Be certain not to apply voltage exceeding the rated voltage of components.
- Do not operate outside the recommended operating temperature range of components.
- Sudden change of temperature shall be avoided, deterioration of the characteristics can occur.
- Be careful of soldering temperature and duration of components when soldering.
- Do not place soldering iron on the body of components.
- Be careful not to subject the terminals or leads of components to excessive force.
- SAW devices are electrostatic sensitive. Please avoid static voltage during operation and storage.
- Ultrasonic cleaning shall be avoided. Ultrasonic vibration may cause destruction of components.

Test Circuit

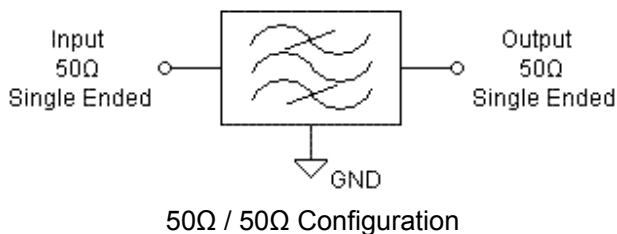

Recommended Land Pattern

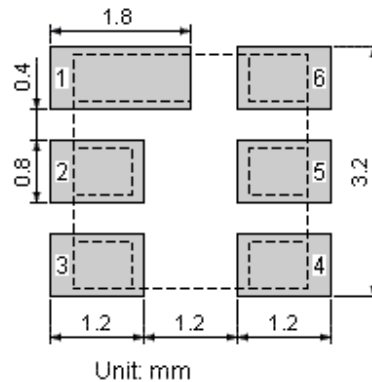

Packing Information

Carrier Tape

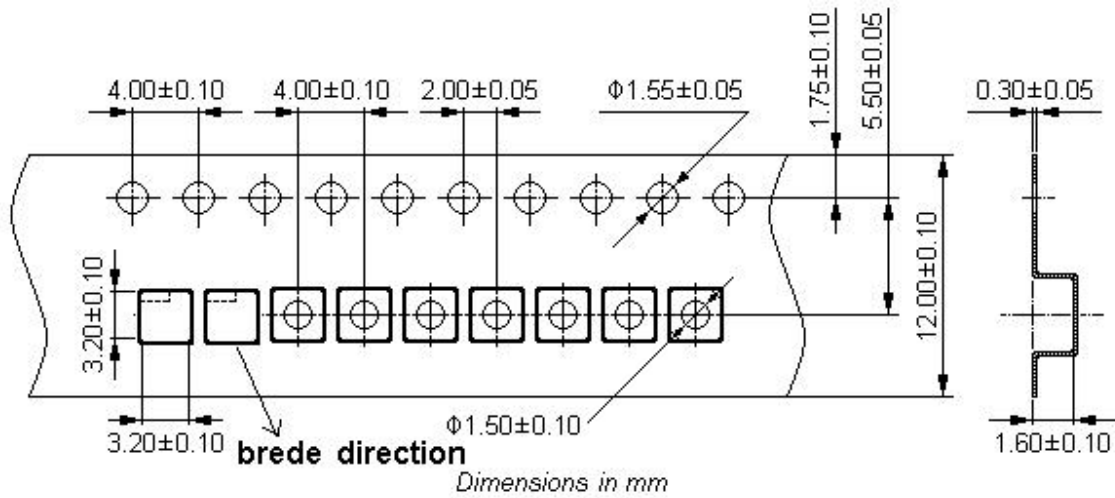

Reel Dimensions

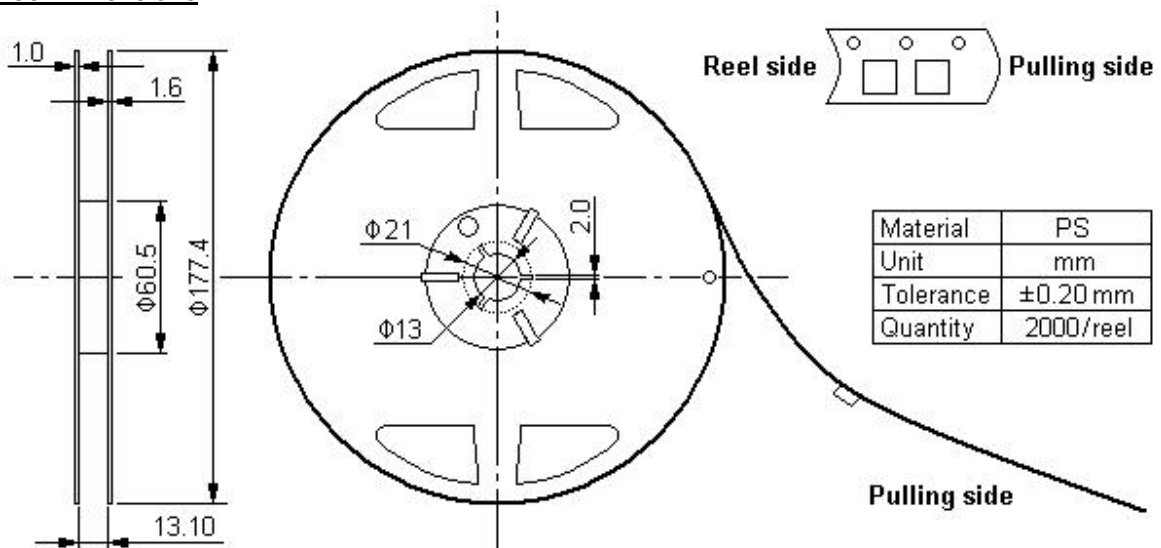

Outer Packing

Type	Quantity	Dimension	Description	Weight
Carton Box I	10000	190×190×95	anti-static plastic bag & carton box 1 reel / bag	0.85
Carton Box II	20000	190×190×190	5 bags / box (10000 pcs) 10 bags / box (20000 pcs)	1.70

Unit: mm

Unit: kg

Recommended Soldering Profile

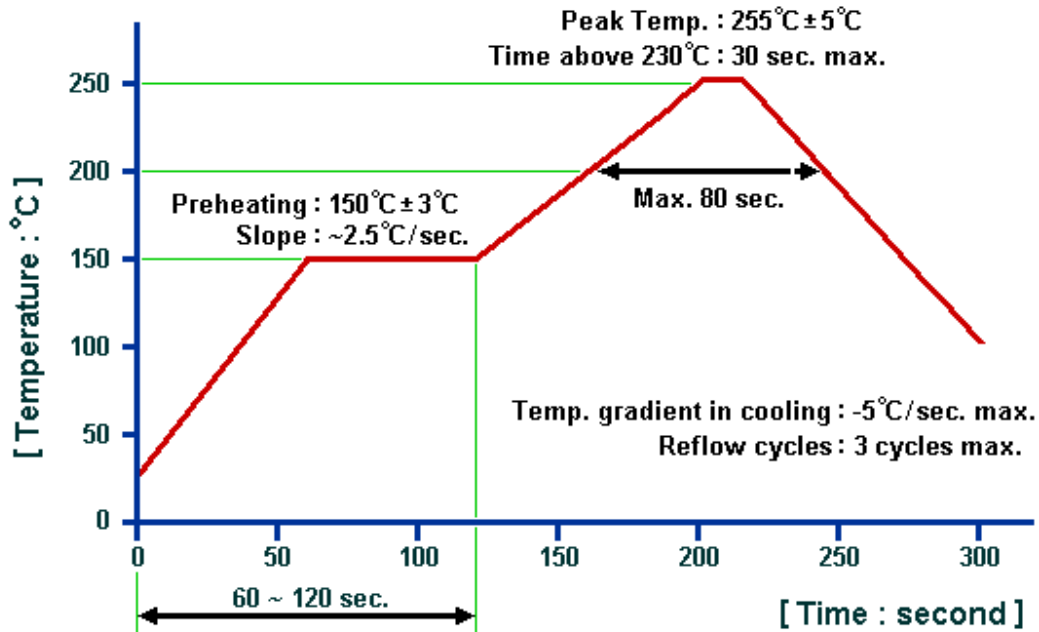

© NEDI 2011. All Rights Reserved.

1. The specifications of this device are subject to change or obsolescence without notice.
2. Typically, equipment utilizing this device requires emissions testing and government approval, which is the responsibility of the equipment manufacturer.
3. Our liability is only assumed for the Surface Acoustic Wave (SAW) component(s) per se, not for applications, processes and circuits implemented within components or assemblies.
4. For questions on technology, prices and delivery, please contact our sales offices or e-mail winnsky@winnsky.com