

Features

- Low-loss RF filter for CDMA450 – Block A&B(Rx)
- High Rejection
- Single Ended Operation at 50Ω without Matching
- Ceramic Package for **Surface Mounted Technology (SMT)**
- Lead-free Production and **RoHS Compliance**

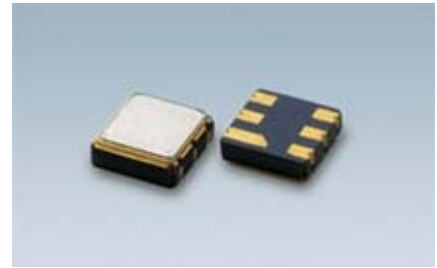

Package Dimensions

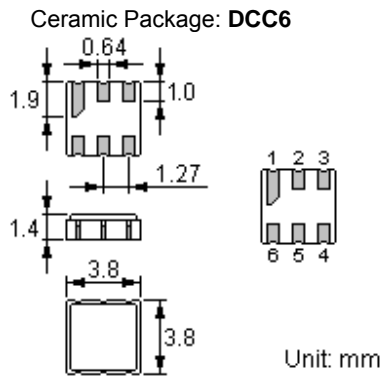

Pin Configuration

2	Input
5	Output
1, 3, 4, 6	Case Ground
1, 3, 4, 6	To Be Grounded

Marking

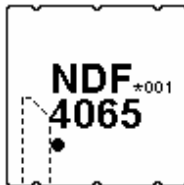

Top View, Laser Marking

- "ND": Manufacturer's mark
- "4065": Part number
- "*": Lot number (The code shown below varies in a 4-year cycle)
- "F": SAW filter
- ".": Terminal 1

Code	1	2	3	4	5	6	7	8	9	10	11	12
2005	A	B	C	D	E	F	G	H	J	K	L	M
2006	N	P	Q	R	S	T	U	V	W	X	Y	Z
2007	a	b	c	d	e	f	g	h	i	j	k	m
2008	n	p	q	r	s	t	u	v	w	x	y	z

Maximum Ratings

Rating		Value	Unit
Operating Temperature Range	T_A	-30 ~ +85	°C
Storage Temperature Range	T_{stg}	-50 ~ +125	°C
DC Voltage (between any Terminals)	V_{DC}	0	V
RF Power (in BW)	P	30 max.	dBm
ESD Voltage (HB)	V_{ESD}	150	V

Electrical Characteristics (-30°C ~ +85°C)

Item		Minimum	Typical	Maximum	Unit
Center Frequency	f_c	-	465.00	-	MHz
Maximum Insertion Loss in 462.5 MHz–467.5 MHz	IL	-	2.5	3.5	dB
Absolute Attenuation	α				
0.30 ... 452.50 MHz		40	45	-	dB
452.50 ... 457.50 MHz		40	48	-	dB
485.00 ... 507.50 MHz		35	45	-	dB
507.50 ... 1000.0 MHz		40	45	-	dB
1000.0 ... 2000.0 MHz		25	30	--	dB
Input VSWR in 462.5 MHz–467.5 MHz		-	1.6:1	2.0:1	
Output VSWR in 462.5 MHz–467.5 MHz		-	1.6:1	2.0:1	
Source / Load Impedance (single ended)		50			Ω

RoHS Compliant

Electrostatic Sensitive Device

Typical Frequency Response

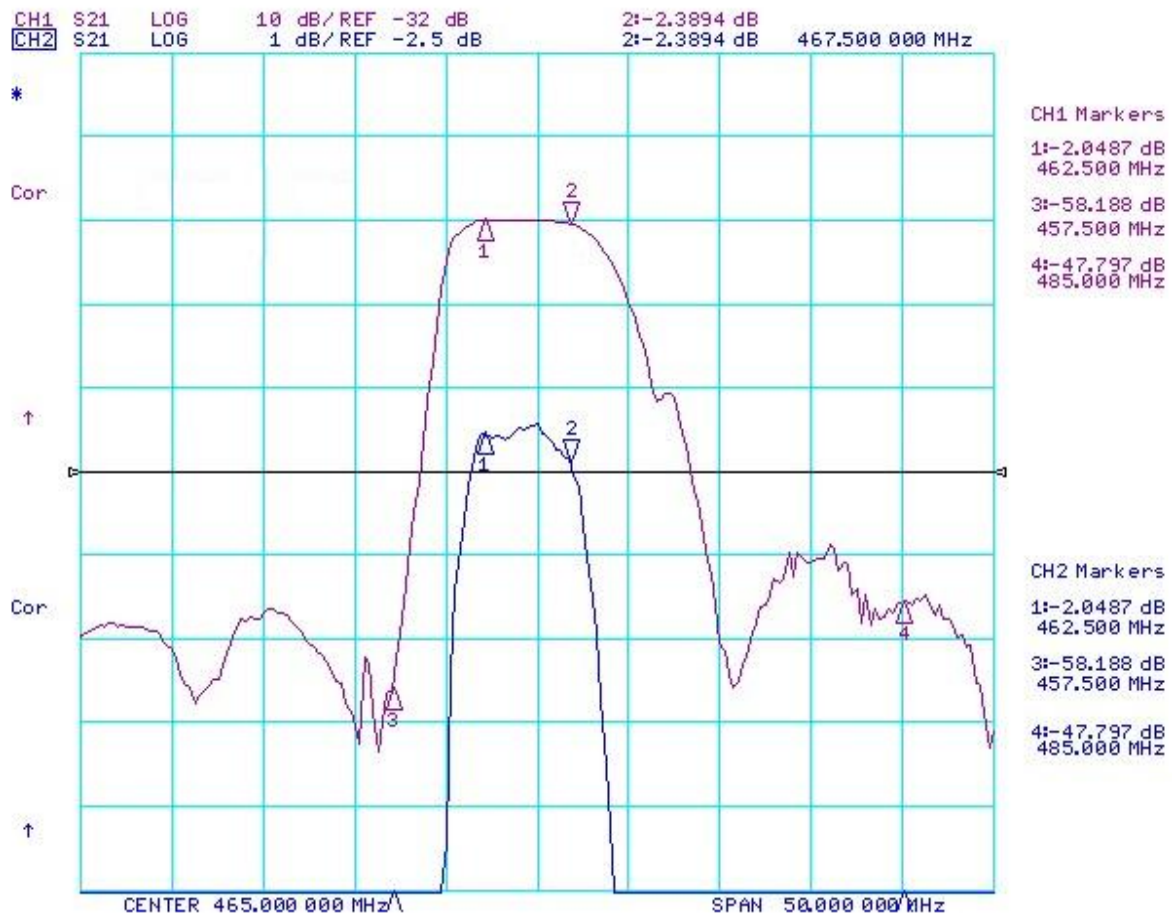

Stability Characteristics

	Test item	Condition of test
1	Mechanical shock	(a) Drops: 3 times on concrete floor (b) Height: 1.0 m
2	Vibration resistance	(a) Frequency of vibration: 10~55Hz (c) Directions: X,Y and Z (b) Amplitude: 1.5 mm (d) Duration: 2 hours
3	Moisture resistance	(a) Condition: 40°C, 90~95% R.H. (c) Wait 4 hours before measurement (b) Duration: 96 hours
4	Climatic sequence	(a) +70°C for 16 hours (c) -25°C for 2 hours (e) Wait 4 hours before measurement (b) +55°C for 24 hours, 90~95% R.H. (d) +40°C for 24 hours, 90~95% R.H.
5	High temperature exposure	(a) Temperature: 70°C (c) Wait 4 hours before measurement (b) Duration: 250 hours
6	Thermal impact	(a) +70°C for 30 minutes ⇒ -25°C for 30 minutes repeated 3 times (b) Wait 4 hours before measurement

Requirements: The SAW filter shall remain within the electrical specifications after tests.

Remarks

- SAW devices should not be used in any type of fluid such as water, oil, organic solvent, etc.
- Be certain not to apply voltage exceeding the rated voltage of components.
- Do not operate outside the recommended operating temperature range of components.
- Sudden change of temperature shall be avoided, deterioration of the characteristics can occur.
- Be careful of soldering temperature and duration of components when soldering.
- Do not place soldering iron on the body of components.
- Be careful not to subject the terminals or leads of components to excessive force.
- SAW devices are electrostatic sensitive. Please avoid static voltage during operation and storage.
- Ultrasonic cleaning shall be avoided. Ultrasonic vibration may cause destruction of components.

Test Circuit

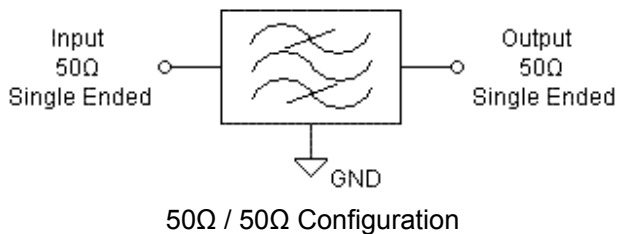

Recommended Land Pattern

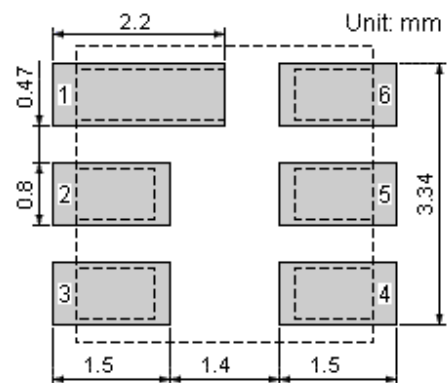

Packing Information

Carrier Tape

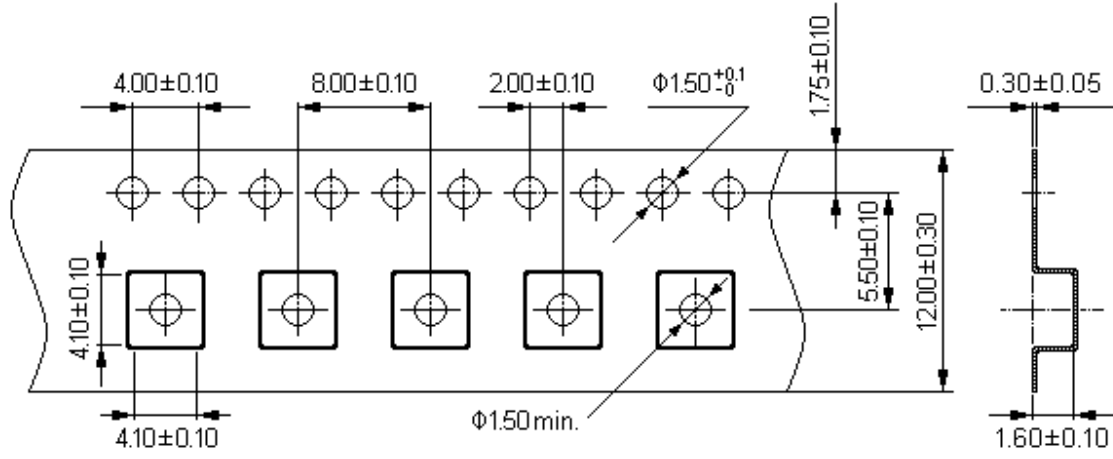

Dimensions in mm

Reel Dimensions

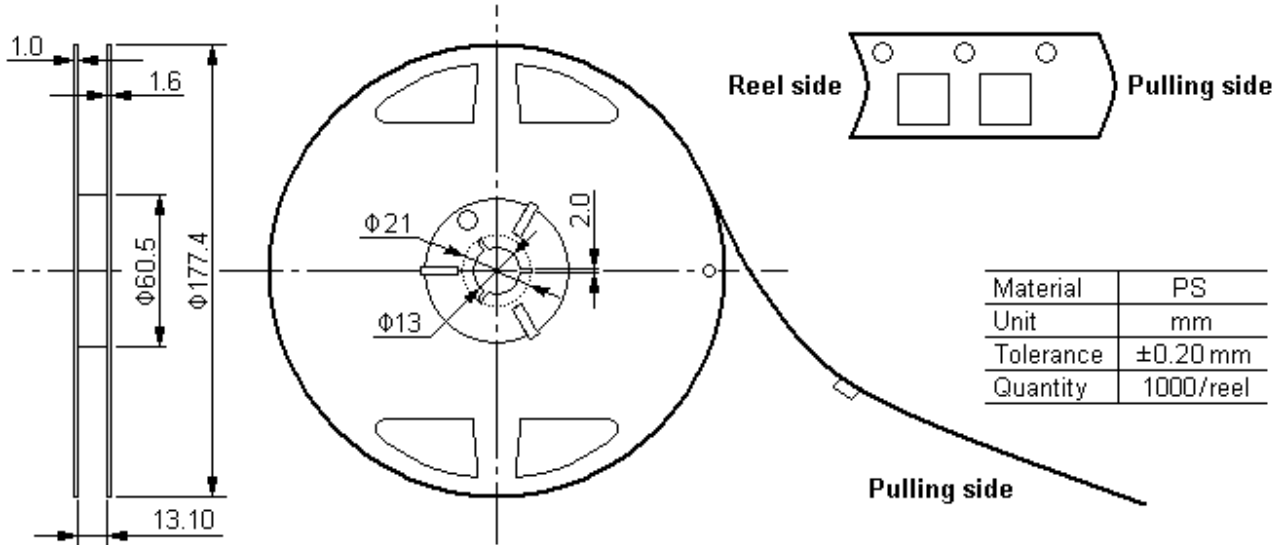

Outer Packing

Type	Quantity	Dimension	Description	Weight
Carton Box I	5000	190×190×95	anti-static plastic bag & carton box 1 reel / bag	0.85
Carton Box II	10000	190×190×190	5 bags / box (5000 pcs) 10 bags / box (10000 pcs)	1.70

Unit: mm

Unit: kg

Recommended Soldering Profile

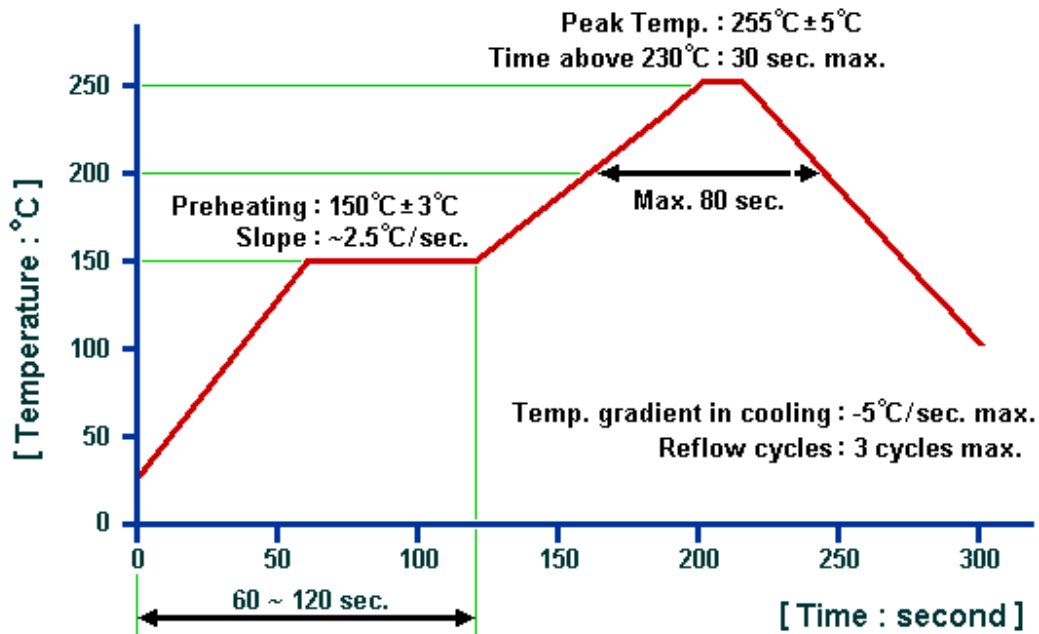

© NEDI 2008. All Rights Reserved.

1. The specifications of this device are subject to change or obsolescence without notice.
2. Typically, equipment utilizing this device requires emissions testing and government approval, which is the responsibility of the equipment manufacturer.
3. Our liability is only assumed for the Surface Acoustic Wave (SAW) component(s) per se, not for applications, processes and circuits implemented within components or assemblies.
4. For questions on technology, prices and delivery, please contact our sales offices or e-mail winnsky@winnsky.com