

1. 概述 INTRODUCTION

微波多层片状陶瓷天线 LA 系列产品设计用于 WLAN、蓝牙天线、PHS，手机多频天线, FM 等小体积 SMD 片式设计。

Microwave Multi-Layer Chip Type Ceramic Antenna LA series are designed to be used in WLAN、Bluetooth、PHS、Multiple-band Mobile phone antenna, FM, etc and compact size SMD chip design.

2. 型号 Part Number

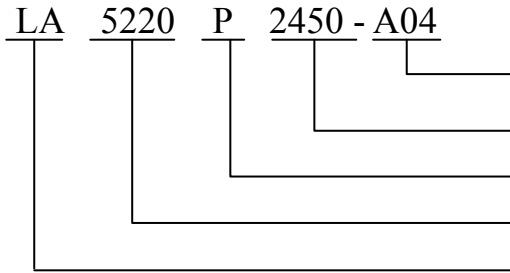

产品名称, 编号 A04/Product Name: A04
 天线频率/Antenna Frequency: 2450 MHz
 产品设计结构 P 型/Planar Structure
 产品尺寸/Size: 5.2×2.0×1.0
 多层结构天线/Multi-layer Antenna

3. 外型尺寸 Dimensions (Unit: mm)

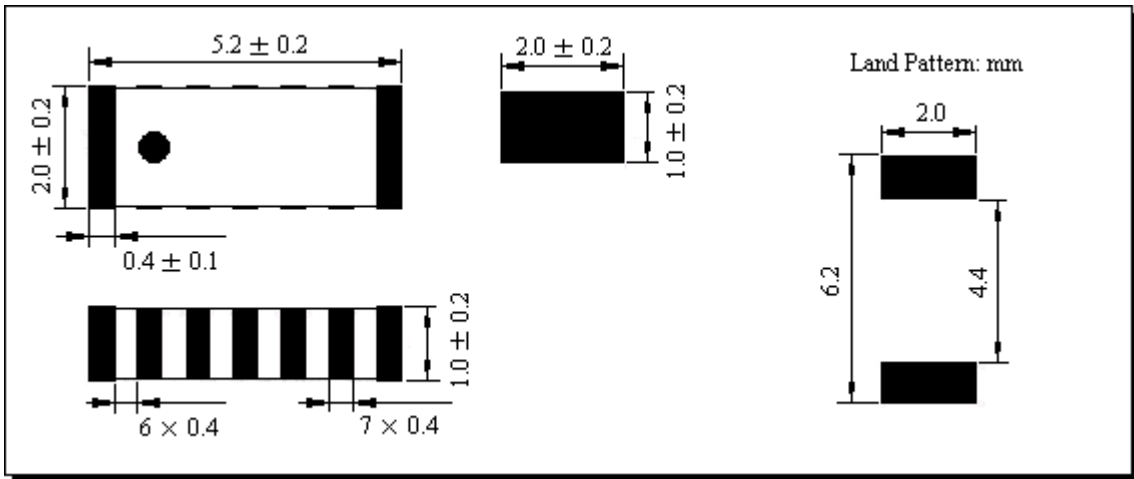

4. 测试电路 Evaluation Board

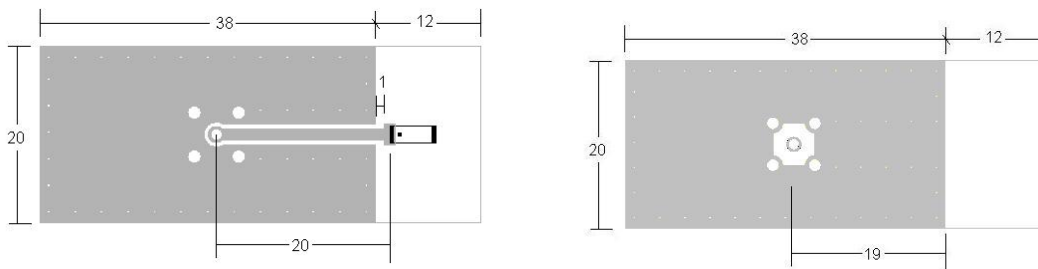

*以上测试电路仅用于测试天线本振频率，实际应用应根据不同 PCB 设计匹配电路来达到 2.45GHz 工作频率

5. 电气性能

Electrical Characteristics

No.	Item (项目)	Specifications (特性)
5.1	Working Central Frequency 中心工作频率	2450 MHz
5.2	Band Width 通带宽度	±75 MHz (2375~2525MHz)
5.3	Gain 增益	0~2 dBi
5.4	V.S.W.R (in BW) 驻波比	≤2.0
5.5	Polarization 极化方式	Linear 线性
5.6	Azimuth Beam width 方位角	Omni-directional 全向
5.7	Impedance 阻抗	50 Ω

6. 特性曲线

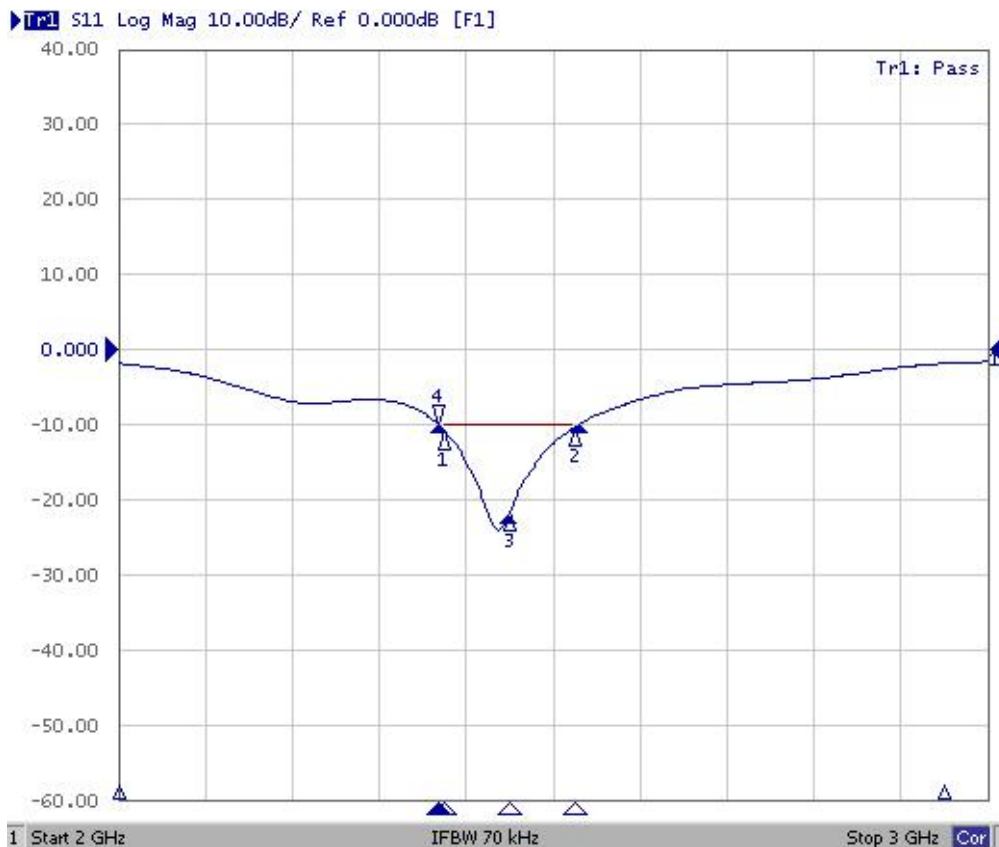
Characteristic curve

7. 方向图 Radiation Pattern

XY-V/XY-H

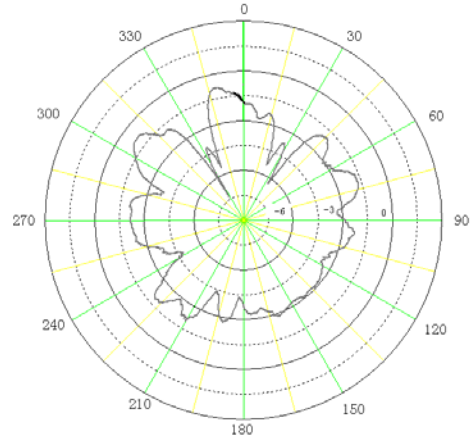
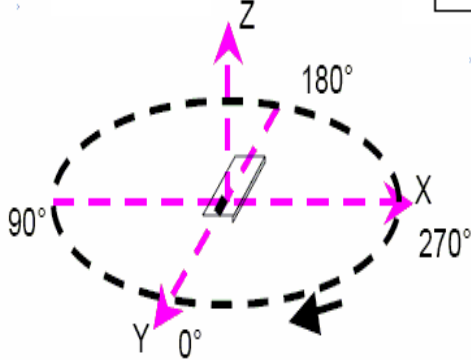

XZ-V/XZ-H

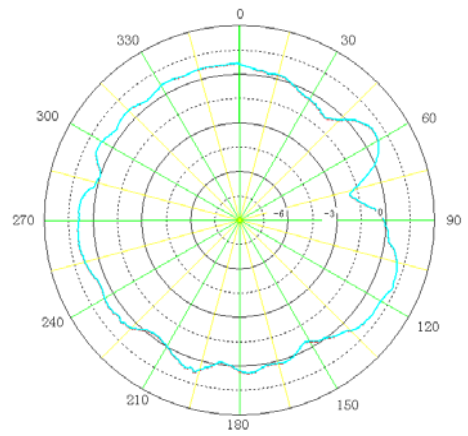
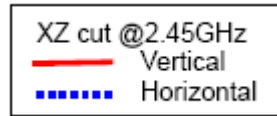
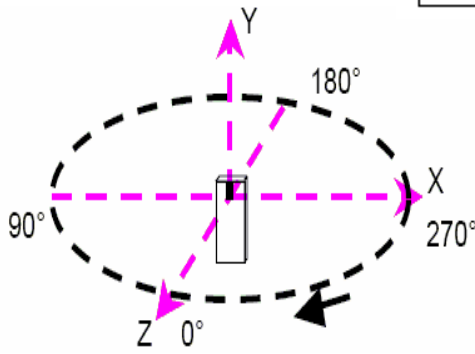

YZ-V/YZ-H

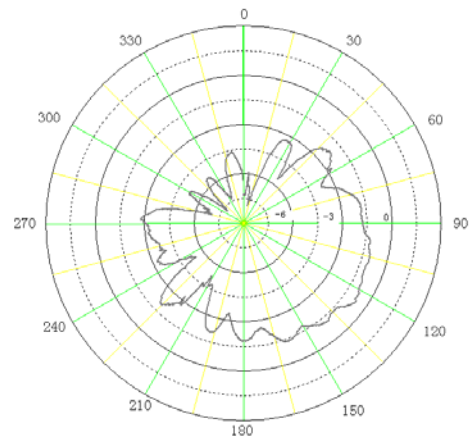
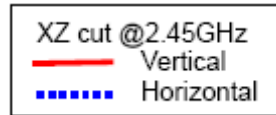
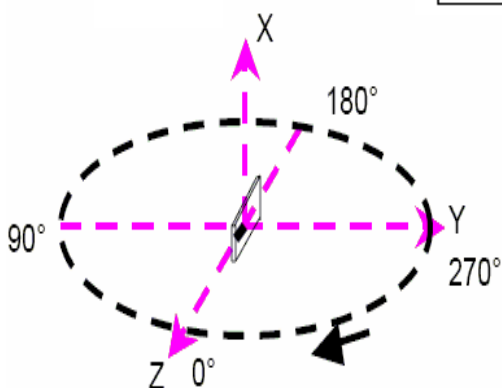

8 环境试验后允许误差 Post Environmental Tolerance

经环境试验后允许比起始读数偏差见下表

No.	Item (项目)	Post Environmental Tolerance (环境试验后允许附加误差)
8.1	Central Frequency 中心频率	± 25 MHz
8.2	Band Width 通带宽度	± 20 MHz
8.3	Gain 增益	± 0.2 dBi
8.4	V.S.W.R (in BW) 驻波比	± 0.5

Post Environmental Tolerance (Refer to the table)

9 环境试验 Environmental Test

基准条件：温度范围	Temperature range	$25 \pm 5^\circ\text{C}$
相对湿度范围	Relative Humidity range	55~75%RH
工作温度	Operating Temperature range	$-40^\circ\text{C} \sim +85^\circ\text{C}$
贮藏温度	Storage Temperature range	$-40^\circ\text{C} \sim +85^\circ\text{C}$

9.1 耐振动 Vibration Resist

在振动频率为 10~55Hz 振幅为 1.5mm 沿 X.Y.Z 方向各振动 2 小时后测试符合表 8.1~8.4 规定。

The device should satisfy the electrical characteristics specified in paragraph 8.1~8.4 after applied to the vibration of 10 to 55Hz with amplitude of 1.5mm for 2 hours each in X, Y and Z directions.

9.2 耐跌落冲击 Drop Shock

在 100cm 高度处按 X, Y, Z 三个面分别自由跌落在木制地板上共 3 次后测试符合表 8.1~8.4 规定。

The device should satisfy the electrical characteristics specified in paragraph 8.1~8.4 after dropping onto the hard wooden board from the height of 100cm for 3 times each facet of the 3 dimensions of the device.

9.3 耐焊接热 Solder Heat Proof

能承受经 120~150°C 的温度预热 120 秒后，在 255°C+10°C 的焊锡浸 5±0.5 秒，或 300°C-10°C 的电烙铁焊接 3±0.5 秒，焊接面无损伤。

The device should be satisfied after preheating at 120°C~150°C for 120 seconds and dipping in soldering Sn at 255°C+10°C for 5±0.5 seconds, or electric iron 300°C-10°C for 3±0.5 seconds, without damage.

9.4 结合力试验 Tensile Strength of Terminal

在产品电极端子上或表面上应能承受 1kg 垂直拉力 10±1 秒。

The device should not be broken after tensile force of 1.0kg is slowly applied to pull a lead pin of the fixed device in the lead axis direction for 10±1 seconds.

9.5 耐弯曲试验 *Bending Resist Test*

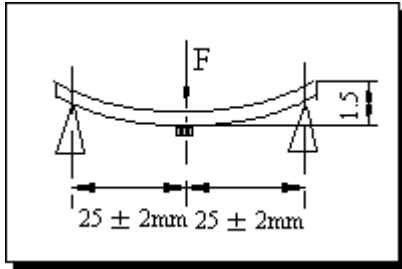

将产品按图焊在 $1.6 \pm 0.2\text{mm}$ 的 PCB 板中间，由箭头方向施力： 1mm/S ，弯曲距离： 1.5mm ，保持 $5 \pm 1\text{S}$ ，产品金属层无脱落。

Weld the product to the center part of the PCB with the thickness $1.6 \pm 0.2\text{mm}$ as the illustration shows, and keep exerting force arrow-ward on it at speed of 1mm/S , and hold for $5 \pm 1\text{S}$ at the position of 1.5mm bending distance, so far, any peeling off of the

product metal coating should not be detected.

9.6 耐湿热特性 *Moisture Proof*

在温度为 $60 \pm 2^\circ\text{C}$ 相对湿度 $90\sim 95\%$ 的恒温湿箱中放置 96 小时，在常温中恢复 1~2 小时后测试，符合表 8.1~8.4 规定。

The device should satisfy the electrical characteristics specified in paragraph 8.1~8.4 after exposed to the temperature $60 \pm 2^\circ\text{C}$ and the relative humidity $90\sim 95\%$ RH for 96 hours and 1~2 hours recovery time under normal condition.

9.7 高温特性 *High Temperature Endurance*

在温度为 $85 \pm 5^\circ\text{C}$ 的恒温箱中放置 96 ± 2 小时，在常温中恢复 1~2 小时后测试。符合表 8.1~8.4 规定。

The device should satisfy the electrical characteristics specified in paragraph 8.1~8.4 after exposed to temperature $85 \pm 5^\circ\text{C}$ for 96 ± 2 hours and 1~2 hours recovery time under normal temperature.

9.8 低温特性 *Low Temperature Endurance*

在温度为 $-40^\circ\text{C} \pm 5^\circ\text{C}$ 低温箱中放置 96 ± 2 小时后恢复 1~2 小时测试符合表 8.1~8.4 规定。

The device should also satisfy the electrical characteristics specified in paragraph 8.1~8.4 after exposed to the temperature $-40^\circ\text{C} \pm 5^\circ\text{C}$ for 96 ± 2 hours and to 2 hours recovery time under normal temperature.

9.9 温度循环 *Temperature Cycle Test*

在 -40°C 温度中保持 30 分钟，再在 $+85^\circ\text{C}$ 温度中保持 30 分钟，共循环 5 次后在常温中恢复 1~2 小时后测试符合表 8.1~8.4 规定。

The device should also satisfy the electrical characteristics specified in paragraph 8.1~8.4 after exposed to the low temperature -40°C and high temperature $+85^\circ\text{C}$ for 30 ± 2 min each by 5 cycles and 1 to 2 hours recovery time under normal temperature.

10 回流焊温度 *Reflow Soldering Standard Condition*

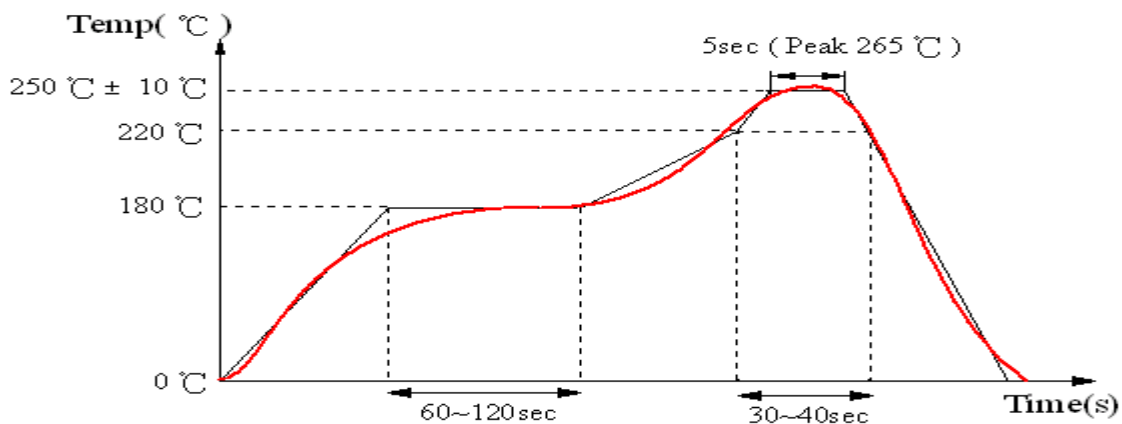

11 包装尺寸 (5220) Packaging and Dimensions

11.1 Plastic Tape

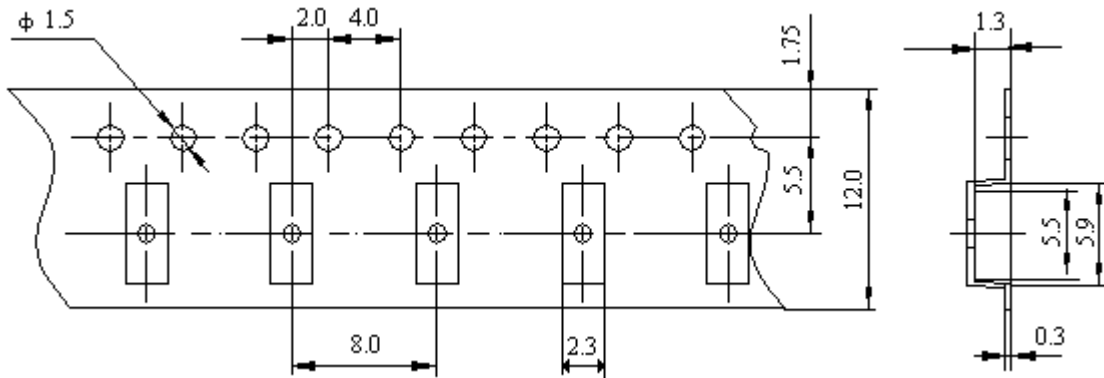

包装说明： Remarks for Package

载带尾部空穴长度 150~200mm，载带头部空穴长度 250~300mm，头部的盖带加长 250mm。

Reserve a length of 150~200mm for the trailer of the carrier and 250~300 mm for the leader of the carrier and further 250mm of cover tape at the leading part of the carrier.

11.2 Reel (1000 pcs/Reel)

