

**Features**

- Low-loss RF filter for CDMA450 – Block A&B(Rx)
- High Rejection
- Single Ended Operation at 50Ω without matching
- Ceramic Package for **Surface Mounted Technology (SMT)**
- Lead-free Production and **RoHS Compliance**

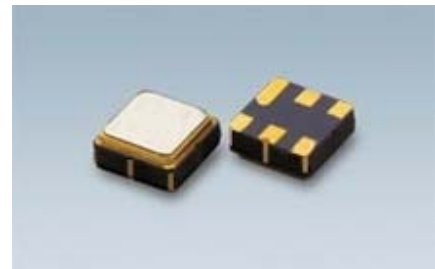

**Package Dimensions**

Ceramic Package: **DCC6C**



**Pin Configuration**

2	Input
5	Output
1, 3, 4, 6	Case Ground
1, 3, 4, 6	To Be Grounded

**Marking**



Top View, Laser Marking

- "ND": Manufacturer's mark
- "F": SAW filter
- "4170": Part number
- ".": Terminal 1
- "\*": Lot number (The code shown below varies in a 4-year cycle)

Code	1	2	3	4	5	6	7	8	9	10	11	12
2009	A	B	C	D	E	F	G	H	J	K	L	M
2010	N	P	Q	R	S	T	U	V	W	X	Y	Z
2011	a	b	c	d	e	f	g	h	i	j	k	m
2012	n	p	q	r	s	t	u	v	w	x	y	z

**Maximum Ratings**

Rating		Value	Unit
Operating Temperature Range	$T_A$	-40 ~ +85	°C
Storage Temperature Range	$T_{stg}$	-40 ~ +85	°C
DC Voltage (between any Terminals)	$V_{DC}$	0	V
RF Power (in BW)	$P$	26 max.	dBm
ESD Voltage (HB)	$V_{ESD}$	250	V

Electrical Characteristics

Item		Minimum	Typical	Maximum	Unit
Center Frequency	$f_c$	-	462.50	-	MHz
Maximum Insertion Loss in 460.0MHz–465.0Hz	$IL$	-	2.0	3.0	dB
Amplitude Variation in 460.0MHz–465.0Hz			0.8	1.2	dB
Absolute Attenuation	$\alpha$				
0.30 ... 450.00 MHz		50	55	-	dB
450.00 ... 455.00 MHz		50	55	-	dB
485.00 ... 800.00 MHz		50	55	-	dB
800.00 ... 1500.0 MHz		40	48	-	dB
1500.0 ... 2000.0 MHz		35	42	--	dB
Input VSWR in 460.0 MHz–465.0 MHz		-	1.4:1	2.0:1	
Output VSWR in 460.0MHz–465.0MHz		-	1.4:1	2.0:1	
Group delay ripple 460.0 MHz–465.0 MHz			60	120	ns
Source / Load Impedance (single ended)			50		$\Omega$

RoHS Compliant

Electrostatic Sensitive Device

Typical Frequency Response

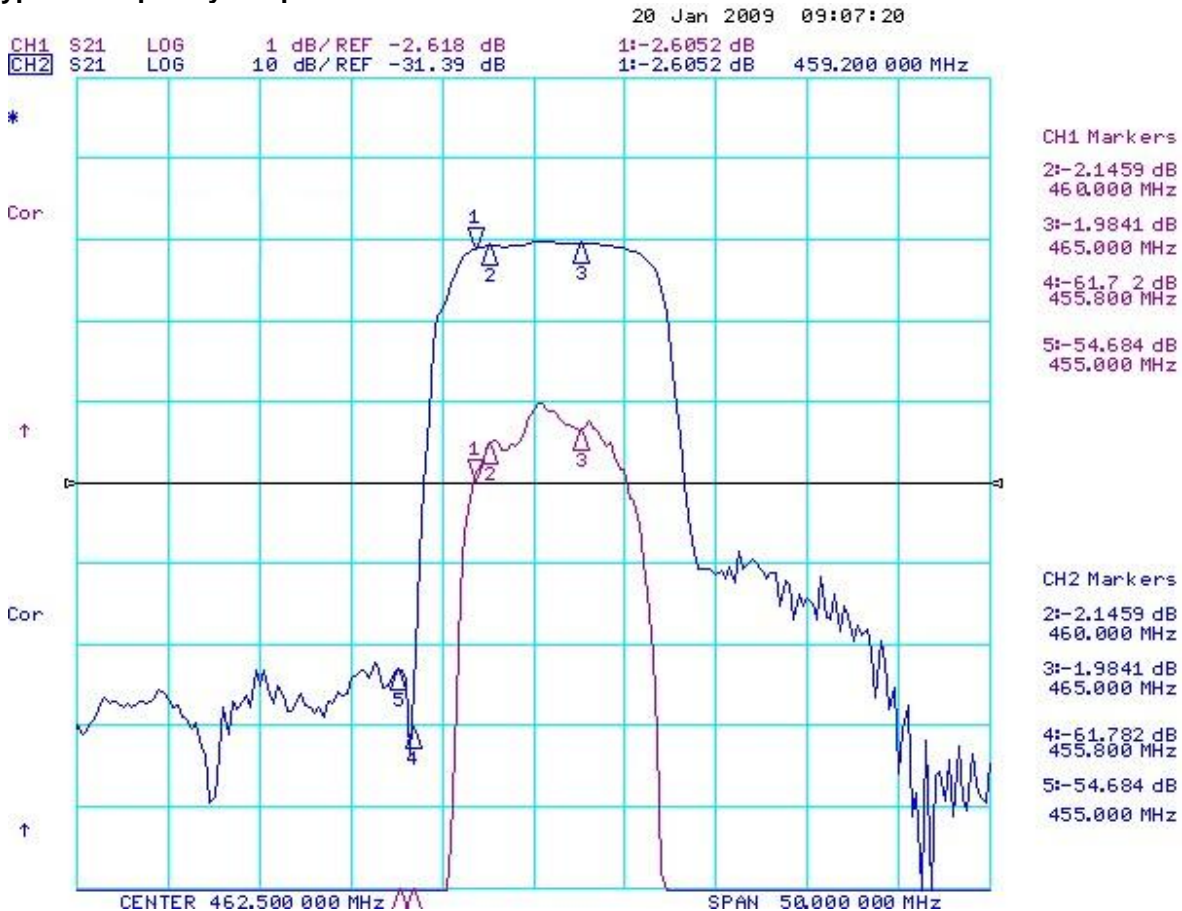

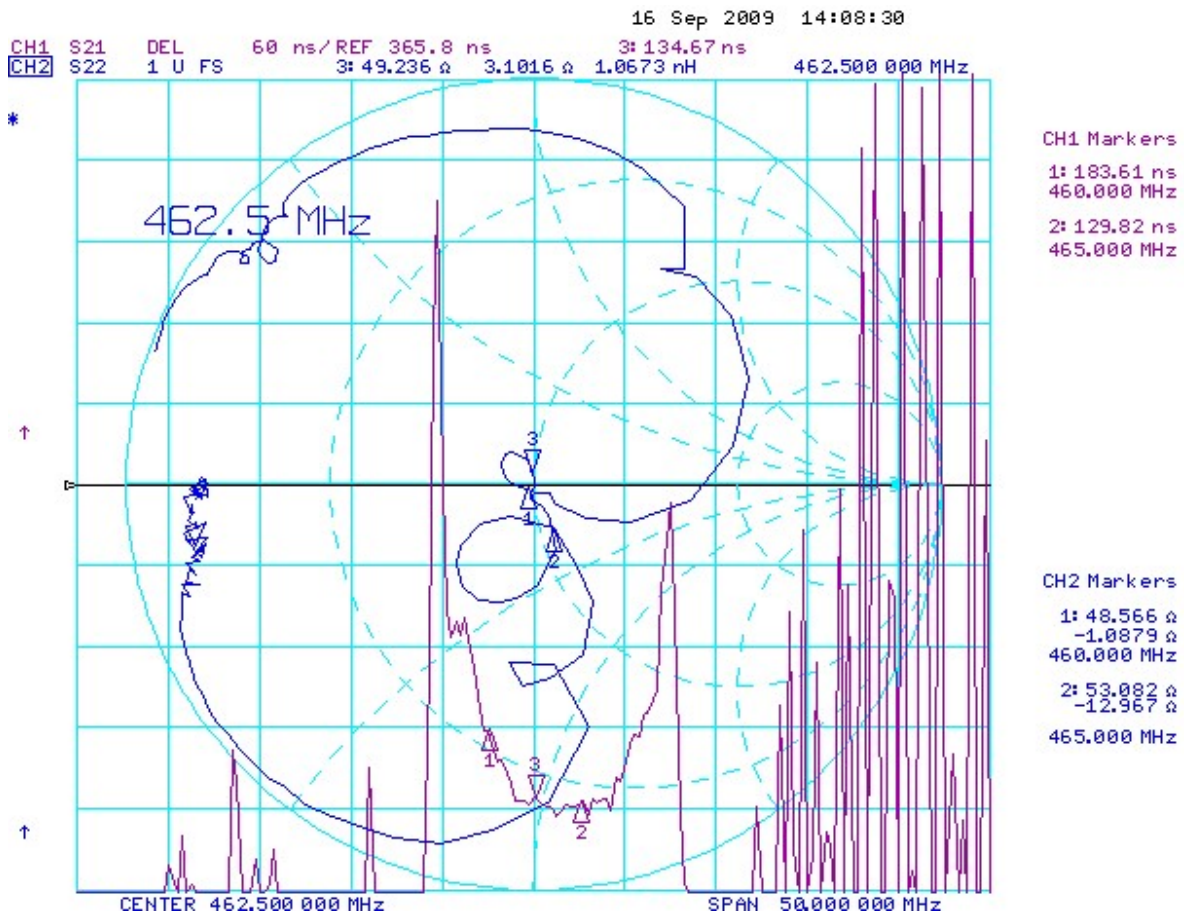

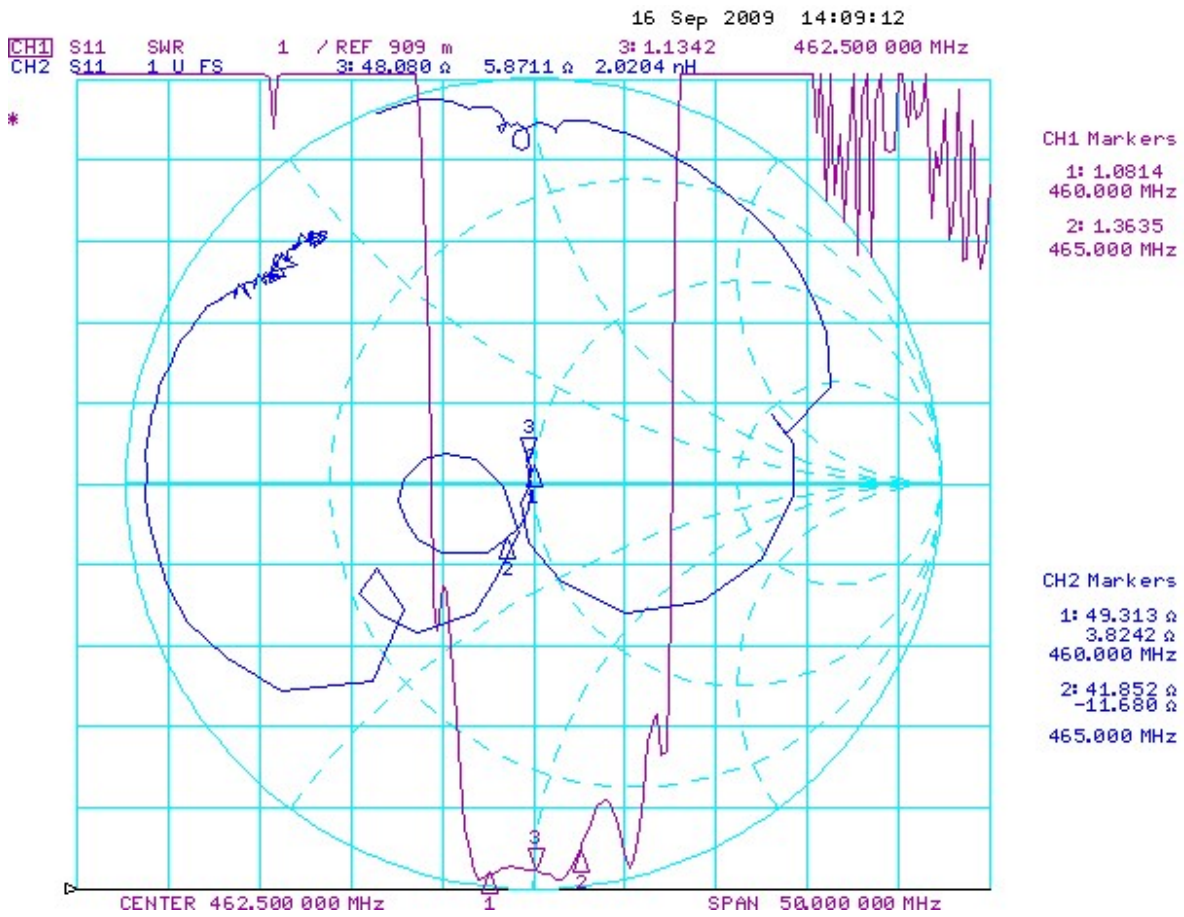

Sta

**Reliability Characteristics**

	Test item	Condition of test
1	Mechanical shock	(a) Drops: 3 times on concrete floor (b) Height: 1.0 m
2	Vibration resistance	(a) Frequency of vibration: 10~55Hz (c) Directions: X,Y and Z (b) Amplitude: 1.5 mm (d) Duration: 2 hours
3	Moisture resistance	(a) Condition: 40°C, 90~95% R.H. (c) Wait 4 hours before measurement (b) Duration: 96 hours
4	Climatic sequence	(a) +70°C for 16 hours (c) -25°C for 2 hours (e) Wait 4 hours before measurement (b) +55°C for 24 hours, 90~95% R.H. (d) +40°C for 24 hours, 90~95% R.H.
5	High temperature exposure	(a) Temperature: 70°C (c) Wait 4 hours before measurement (b) Duration: 250 hours
6	Thermal impact	(a) +70°C for 30 minutes ⇒ -25°C for 30 minutes repeated 3 times (b) Wait 4 hours before measurement

**Requirements:** The SAW filter shall remain within the electrical specifications after tests.

**Remarks**

- SAW devices should not be used in any type of fluid such as water, oil, organic solvent, etc.
- Be certain not to apply voltage exceeding the rated voltage of components.
- Do not operate outside the recommended operating temperature range of components.
- Sudden change of temperature shall be avoided, deterioration of the characteristics can occur.
- Be careful of soldering temperature and duration of components when soldering.
- Do not place soldering iron on the body of components.
- Be careful not to subject the terminals or leads of components to excessive force.
- SAW devices are electrostatic sensitive. Please avoid static voltage during operation and storage.
- Ultrasonic cleaning shall be avoided. Ultrasonic vibration may cause destruction of components.

**Test Circuit**

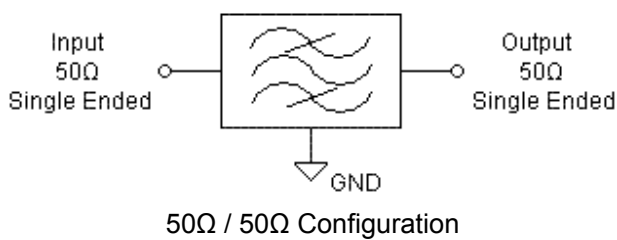

**Recommended Land Pattern**

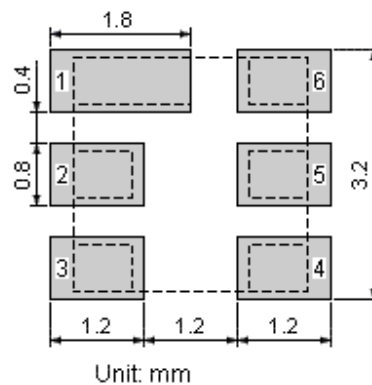

**Packing Information**

Carrier Tape

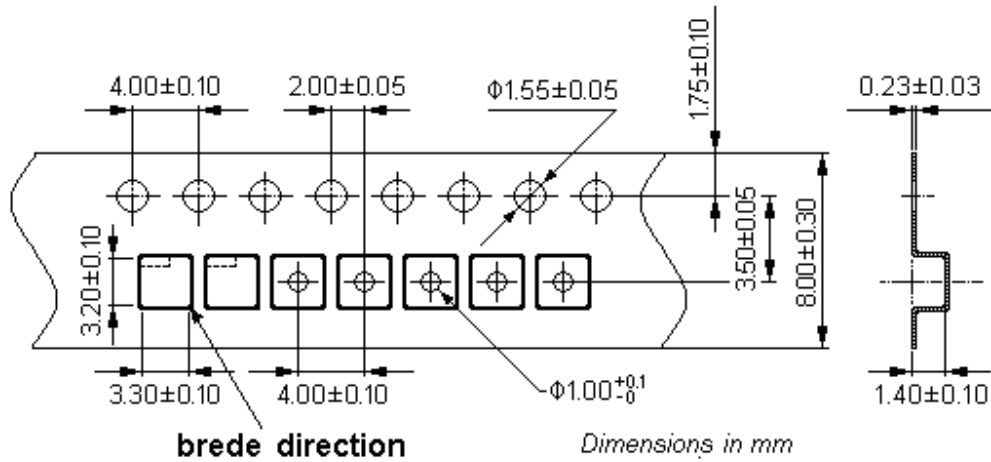

Reel Dimensions

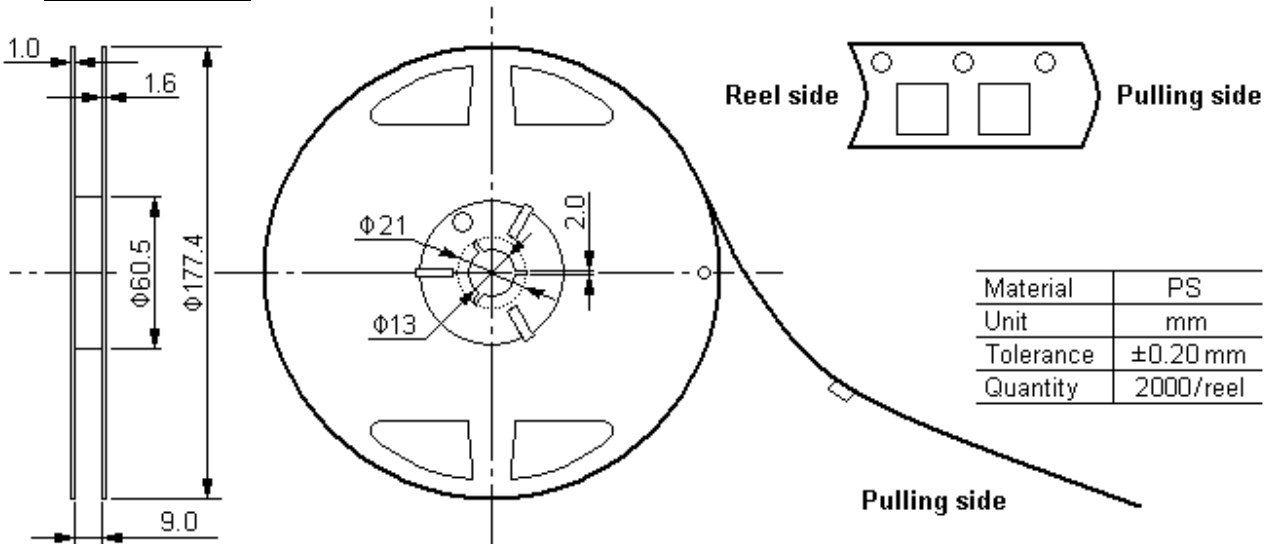

Outer Packing

Type	Quantity	Dimension	Description	Weight
Carton Box I	10000	190×190×95	anti-static plastic bag & carton box 1 reel / bag	0.85
Carton Box II	20000	190×190×190	5 bags / box (10000 pcs) 10 bags / box (20000 pcs)	1.70

Unit: mm

Unit: kg

**Recommended Soldering Profile**

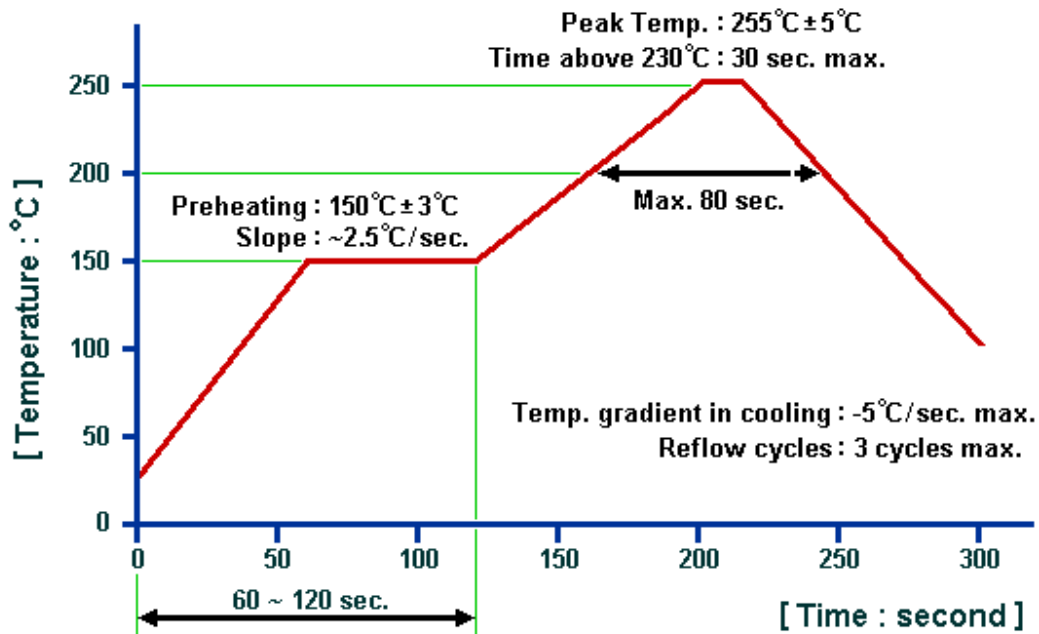

**© NEDI 2009. All Rights Reserved.**

1. The specifications of this device are subject to change or obsolescence without notice.
2. Typically, equipment utilizing this device requires emissions testing and government approval, which is the responsibility of the equipment manufacturer.
3. Our liability is only assumed for the Surface Acoustic Wave (SAW) component(s) per se, not for applications, processes and circuits implemented within components or assemblies.
4. For questions on technology, prices and delivery, please contact our sales offices or e-mail [winnsky@winnsky.com](mailto:winnsky@winnsky.com)