

Features

- Low-loss RF filter for mobile systems
- Low amplitude ripple
- No matching network required for operation at 50Ω
- Ceramic package for **Surface Mounted Technology (SMT)**
- Lead-free production and **RoHS** compliant

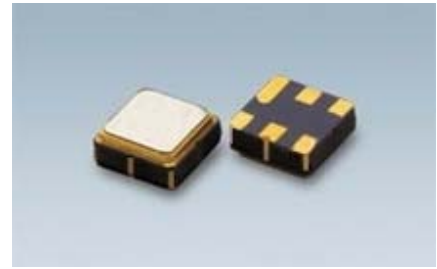

Package Dimensions

Ceramic Package: **DCC6C**

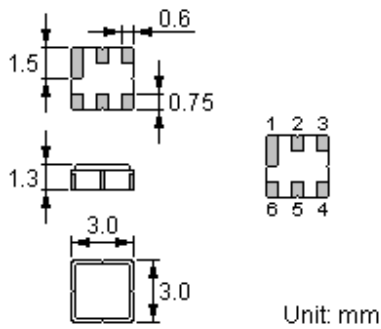

Pin Configuration

2	Input
5	Output
1, 3, 4, 6	Ground

Marking



Top View, Laser Marking

- "ND": Manufacturer's mark
- "F": SAW filter
- "8077": Part number
- Terminal 1
- "*": Lot number (The code shown below varies in a 4-year cycle)

Code	1	2	3	4	5	6	7	8	9	10	11	12
2009	A	B	C	D	E	F	G	H	J	K	L	M
2010	N	P	Q	R	S	T	U	V	W	X	Y	Z
2011	a	b	c	d	e	f	g	h	i	j	k	m
2012	n	p	q	r	s	t	u	v	w	x	y	z

Maximum Ratings

Rating	Value	Unit
Input Power Level	P	20 dBm
DC Voltage	V_{DC}	0 V
Operating Temperature Range	T_A	-20 ~ +60 °C
Storage Temperature Range	T_{stg}	-40 ~ +85 °C

Electrical Characteristics

Item	Minimum	Typical	Maximum	Unit
Center Frequency f_c		800		MHz
Insertion Loss 790.00 810.00 MHz IL		2.2	3.0	dB
Group Delay Ripple 790.00 810.00 MHz		35	70	ns
Absolute Attenuation α				
0.3 620.00 MHz	30	35		dB
620.00 770.00 MHz	30	35		dB
832.00 852.00 MHz	32	36		dB
852.00 2000.00 MHz	30	35		dB
2000.0 3000.0 MHz	25	33		dB
Amplitude Ripple (p-p) 790.00 810.00 MHz $\Delta\alpha$		0.7	1.5	dB
Input/ Output VSWR 790.00 810.00 MHz		1.7	2.1	
Input / Output Impedance (Nominal)	50			Ω

RoHS Compliant

Electrostatic Sensitive Device

Typical Frequency Response

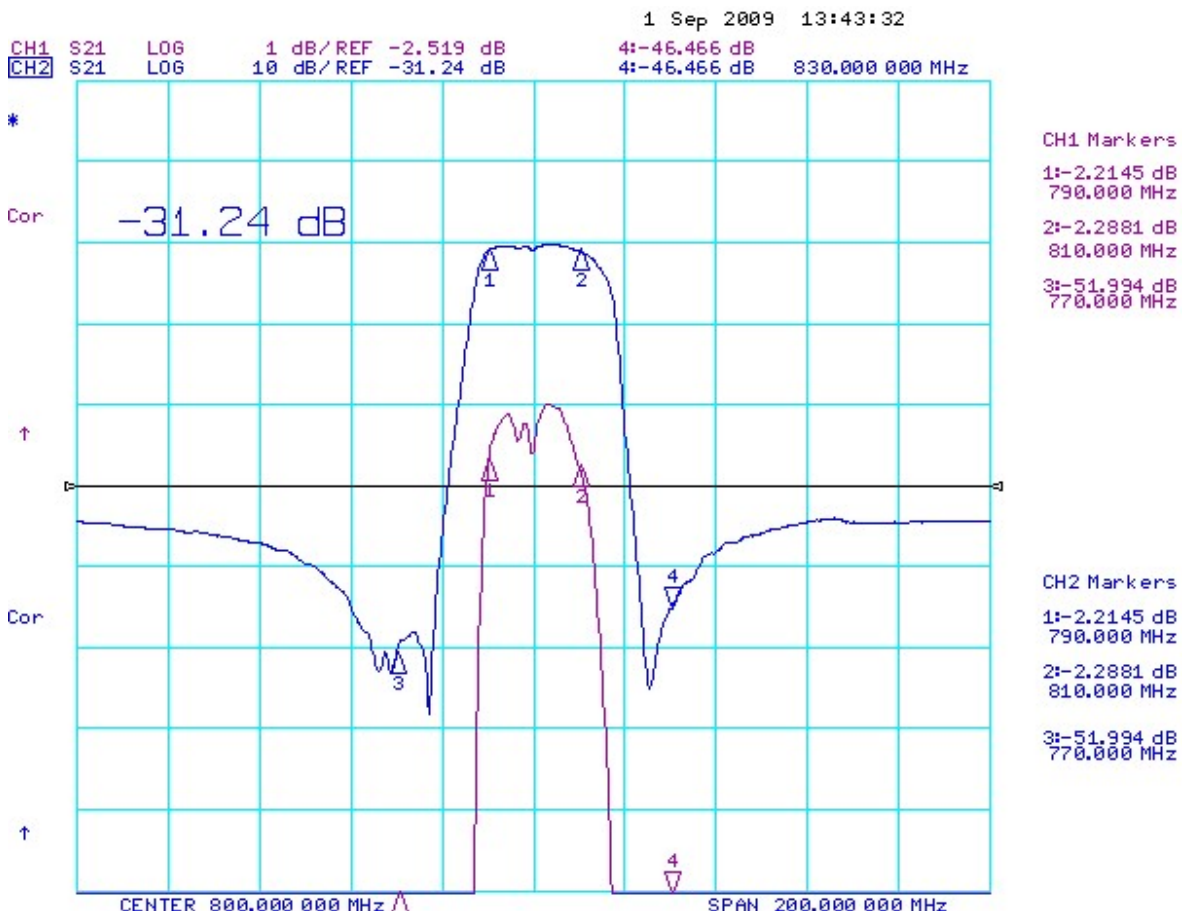

Stability Characteristics

	Test item	Condition of test
1	Mechanical shock	(a) Drops: 3 times on concrete floor (b) Height: 1.0 m
2	Vibration resistance	(a) Frequency of vibration: 10~55Hz (c) Directions: X,Y and Z (b) Amplitude: 1.5 mm (d) Duration: 2 hours
3	Moisture resistance	(a) Condition: 40°C, 90~95% R.H. (c) Wait 4 hours before measurement (b) Duration: 96 hours
4	Climatic sequence	(a) +70°C for 16 hours (c) -25°C for 2 hours (e) Wait 4 hours before measurement (b) +55°C for 24 hours, 90~95% R.H. (d) +40°C for 24 hours, 90~95% R.H.
5	High temperature exposure	(a) Temperature: 70°C (c) Wait 4 hours before measurement (b) Duration: 250 hours
6	Thermal impact	(a) +70°C for 30 minutes ⇒ -25°C for 30 minutes repeated 3 times (b) Wait 4 hours before measurement

Requirements: The SAW filter shall remain within the electrical specifications after tests.

Remarks

- SAW devices should not be used in any type of fluid such as water, oil, organic solvent, etc.
- Be certain not to apply voltage exceeding the rated voltage of components.
- Do not operate outside the recommended operating temperature range of components.
- Sudden change of temperature shall be avoided, deterioration of the characteristics can occur.
- Be careful of soldering temperature and duration of components when soldering.
- Do not place soldering iron on the body of components.
- Be careful not to subject the terminals or leads of components to excessive force.
- SAW devices are electrostatic sensitive. Please avoid static voltage during operation and storage.
- Ultrasonic cleaning shall be avoided. Ultrasonic vibration may cause destruction of components.

Test Circuit

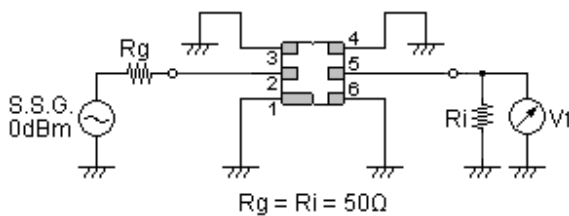

Recommended Land Pattern

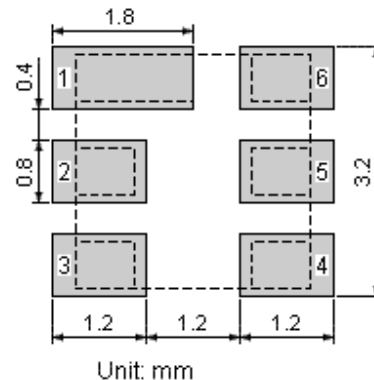

Packing Information

Carrier Tape

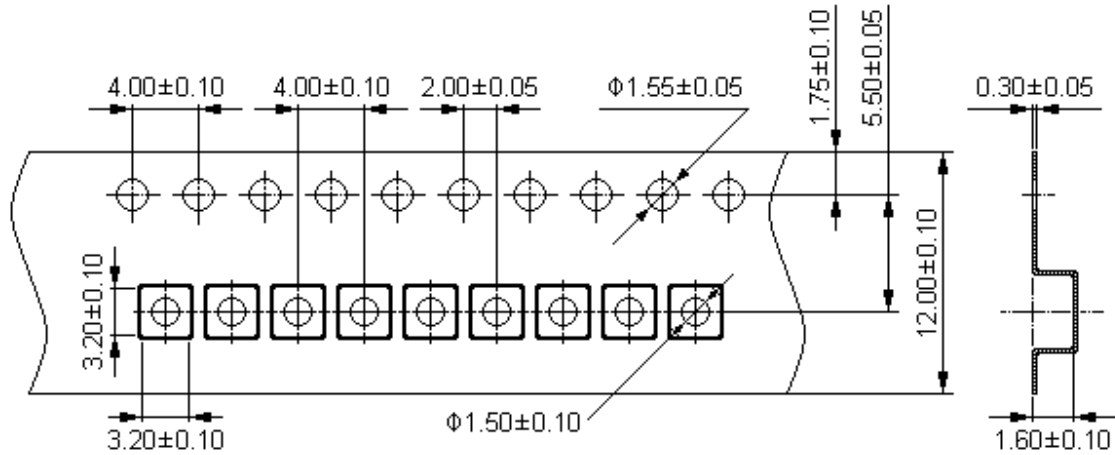

Dimensions in mm

Reel Dimensions

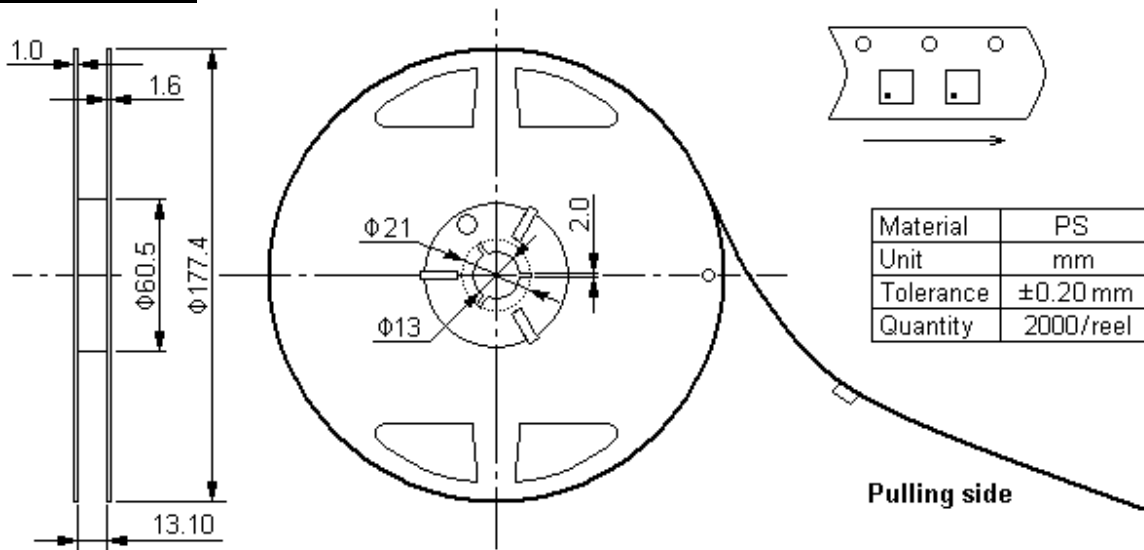

Outer Packing

Type	Quantity	Dimension	Description	Weight
Carton Box I	10000	190×190×95	anti-static plastic bag & carton box 1 reel / bag	0.85
Carton Box II	20000	190×190×190	5 bags / box (10000 pcs) 10 bags / box (20000 pcs)	1.80

Unit: mm

Unit: kg

Recommended Soldering Profile

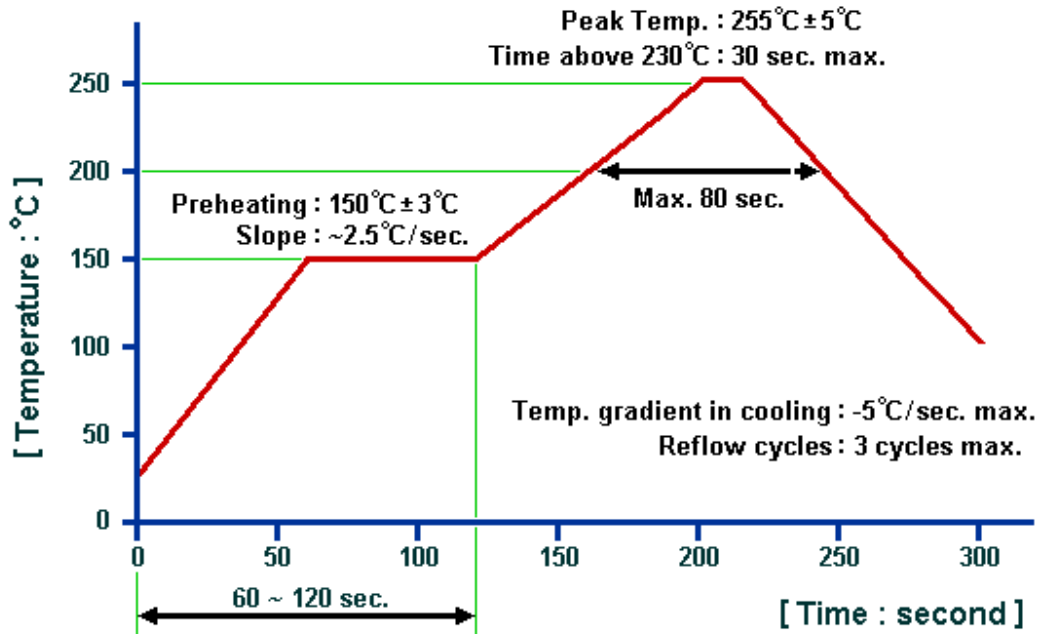

© NEDI 2009. All Rights Reserved.

1. The specifications of this device are subject to change or obsolescence without notice.
2. Typically, equipment utilizing this device requires emissions testing and government approval, which is the responsibility of the equipment manufacturer.
3. Our liability is only assumed for the Surface Acoustic Wave (SAW) component(s) per se, not for applications, processes and circuits implemented within components or assemblies.
4. For questions on technology, prices and delivery, please contact our sales offices or e-mail winnsky@winnsky.com