

**Features**

- Low-loss RF filter for mobile systems
- Low amplitude ripple
- No matching network required for operation at 50Ω
- Ceramic package for **Surface Mounted Technology (SMT)**
- Lead-free production and **RoHS** compliant

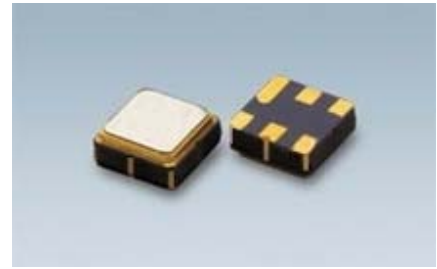

**Package Dimensions**

Ceramic Package: **DCC6C**

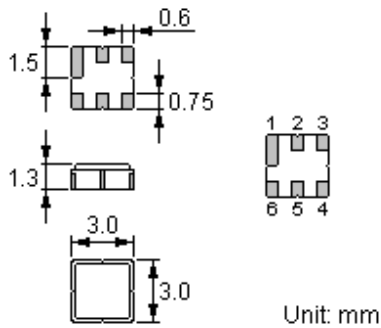

**Pin Configuration**

2	Input
5	Output
1, 3, 4, 6	Ground

**Marking**



Top View, Laser Marking

- "ND": Manufacturer's mark
- "8084": Part number
- "F": SAW filter

**NDF8084**

**Maximum Ratings**

Rating		Value	Unit
Input Power Level	$P$	10	dBm
DC Voltage	$V_{DC}$	12	V
Operating Temperature Range	$T_A$	-40 ~ +85	°C
Storage Temperature Range	$T_{stg}$	-40 ~ +85	°C

**Electrical Characteristics**

Parameter	Unit	Minimum	Typical	Maximum
Center frequency	MHz		879	
Insertion Loss (864~894MHz)	dB		2.0	3.0
Amplitude Variation(864~894MHz)	dB		0.5	1.0
Group delay Variation(864~894MHz)	ns		30	50
Absolute Attenuation	10~705MHz	dB	50	60
	705~755MHz	dB	48	59
	755~805MHz	dB	47	57
	912~939MHz	dB	18	23
	939~979MHz	dB	35	45
	979~1035MHz	dB	43	55
	1035~2600MHz	dB	25	30
Input/Output Return Loss(864~894MHz)	dB	10	14	
RF Power	dBm			+15
Input/Output Impedance	ohm		50	

 RoHS Compliant

 Electrostatic Sensitive Device

Typical Frequency Response

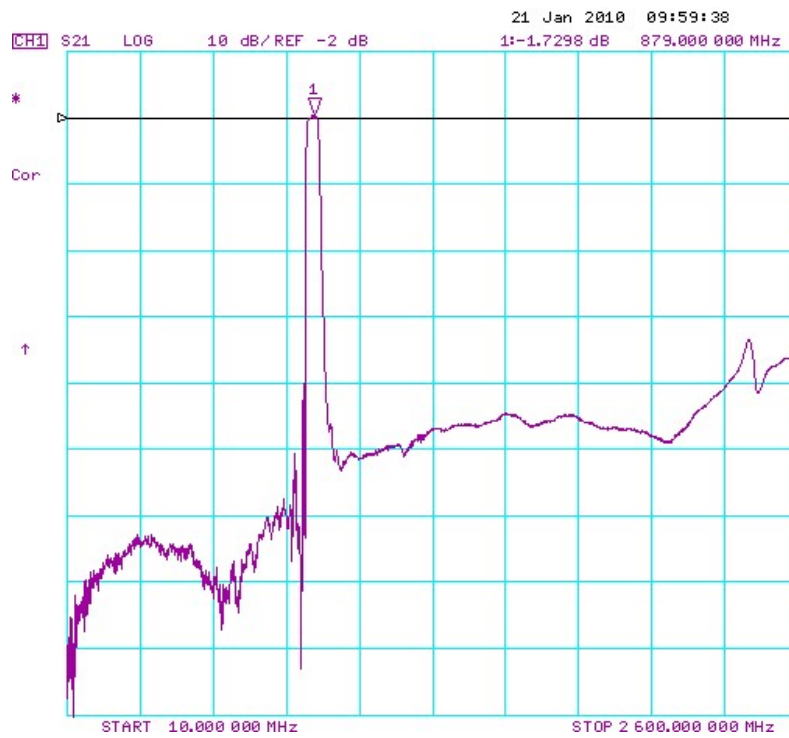
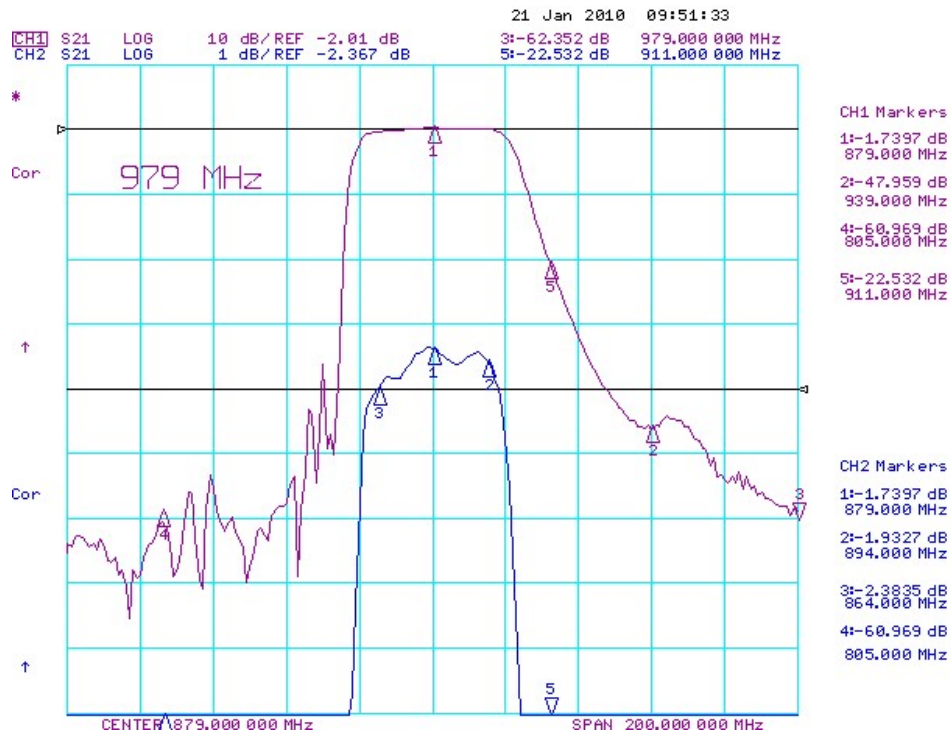

**Stability Characteristics**

	Test item	Condition of test
1	Mechanical shock	(a) Drops: 3 times on concrete floor (b) Height: 1.0 m
2	Vibration resistance	(a) Frequency of vibration: 10~55Hz (c) Directions: X,Y and Z (b) Amplitude: 1.5 mm (d) Duration: 2 hours
3	Moisture resistance	(a) Condition: 40°C, 90~95% R.H. (c) Wait 4 hours before measurement (b) Duration: 96 hours
4	Climatic sequence	(a) +70°C for 16 hours (c) -25°C for 2 hours (e) Wait 4 hours before measurement (b) +55°C for 24 hours, 90~95% R.H. (d) +40°C for 24 hours, 90~95% R.H.
5	High temperature exposure	(a) Temperature: 70°C (c) Wait 4 hours before measurement (b) Duration: 250 hours
6	Thermal impact	(a) +70°C for 30 minutes ⇒ -25°C for 30 minutes repeated 3 times (b) Wait 4 hours before measurement

**Requirements:** The SAW filter shall remain within the electrical specifications after tests.

**Remarks**

- SAW devices should not be used in any type of fluid such as water, oil, organic solvent, etc.
- Be certain not to apply voltage exceeding the rated voltage of components.
- Do not operate outside the recommended operating temperature range of components.
- Sudden change of temperature shall be avoided, deterioration of the characteristics can occur.
- Be careful of soldering temperature and duration of components when soldering.
- Do not place soldering iron on the body of components.
- Be careful not to subject the terminals or leads of components to excessive force.
- SAW devices are electrostatic sensitive. Please avoid static voltage during operation and storage.
- Ultrasonic cleaning shall be avoided. Ultrasonic vibration may cause destruction of components.

**Test Circuit**

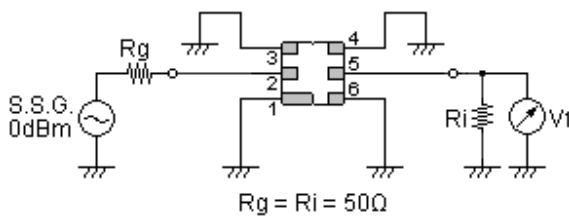

**Recommended Land Pattern**

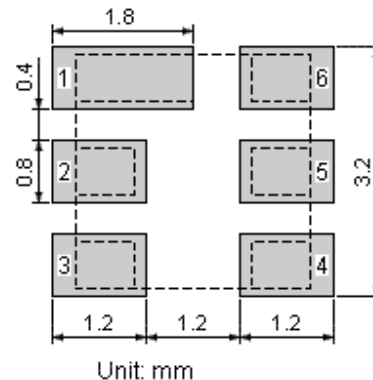

**Packing Information**

Carrier Tape

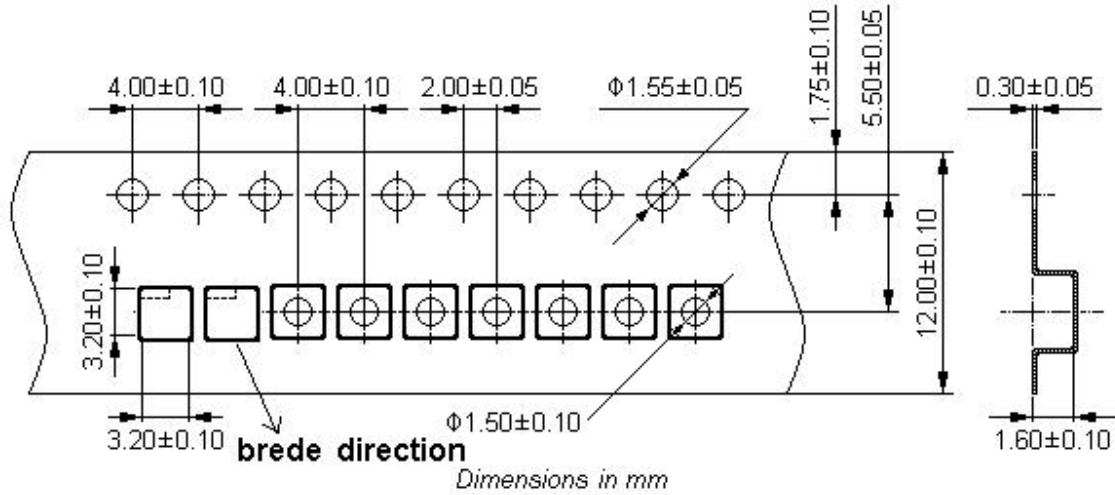

Reel Dimensions

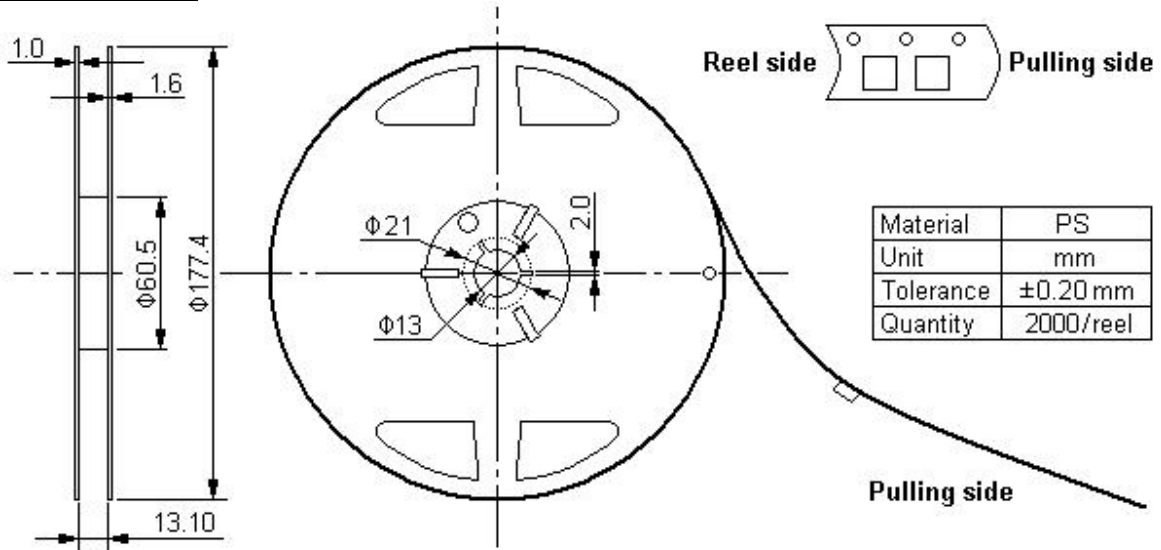

Outer Packing

Type	Quantity	Dimension	Description	Weight
Carton Box I	10000	190×190×95	anti-static plastic bag & carton box 1 reel / bag	0.85
Carton Box II	20000	190×190×190	5 bags / box (10000 pcs) 10 bags / box (20000 pcs)	1.80

Unit: mm

Unit: kg

**Recommended Soldering Profile**

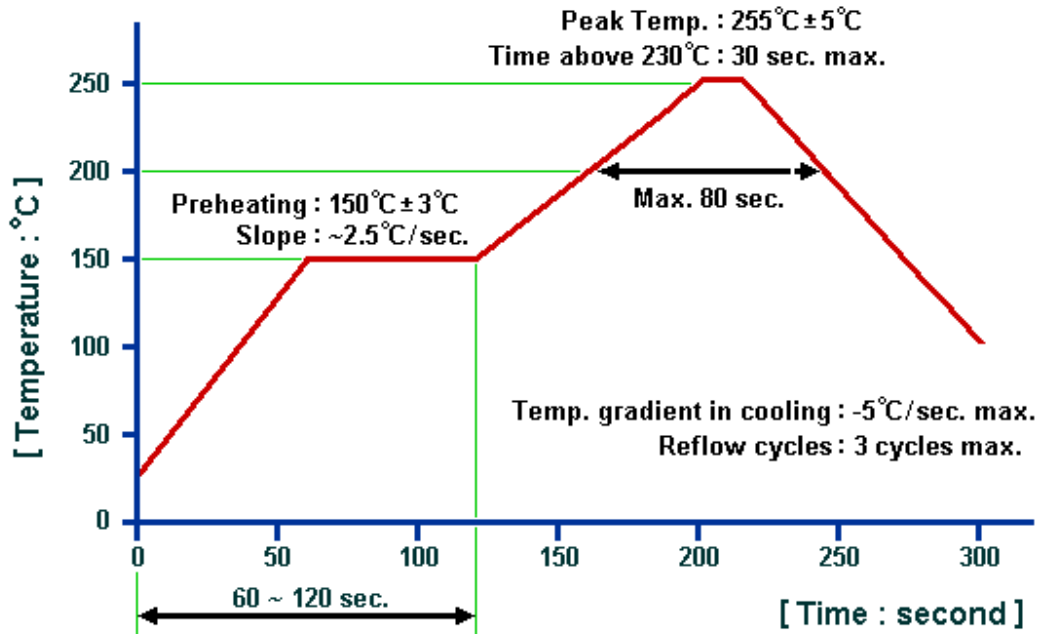

© NEDI 2009. All Rights Reserved.

1. The specifications of this device are subject to change or obsolescence without notice.
2. Typically, equipment utilizing this device requires emissions testing and government approval, which is the responsibility of the equipment manufacturer.
3. Our liability is only assumed for the Surface Acoustic Wave (SAW) component(s) per se, not for applications, processes and circuits implemented within components or assemblies.
4. For questions on technology, prices and delivery, please contact our sales offices or e-mail [winnsky@winnsky.com](mailto:winnsky@winnsky.com)